

HIKVISION



Network Bullet Camera

Quick Start Guide

UD04288B

Quick Start Guide

COPYRIGHT ©2017 Hangzhou Hikvision Digital Technology Co., Ltd.

ALL RIGHTS RESERVED.

Any and all information, including, among others, wordings, pictures, graphs are the properties of Hangzhou Hikvision Digital Technology Co., Ltd. or its subsidiaries (hereinafter referred to be “Hikvision”). This user manual (hereinafter referred to be “the Manual”) cannot be reproduced, changed, translated, or distributed, partially or wholly, by any means, without the prior written permission of Hikvision. Unless otherwise stipulated, Hikvision does not make any warranties, guarantees or representations, express or implied, regarding to the Manual.

About this Manual

This Manual is applicable to 16xx & 26xx Network Bullet Camera.

The Manual includes instructions for using and managing the product. Pictures, charts, images and all other information hereinafter are for description and explanation only. The information contained in the Manual is subject to change, without notice, due to firmware updates or other reasons. Please find the latest version in the company website (<http://overseas.hikvision.com/en/>).

Please use this user manual under the guidance of professionals.

Trademarks Acknowledgement

HIKVISION and other Hikvision’s trademarks and logos are the properties of Hikvision in various jurisdictions. Other trademarks and logos mentioned below are the properties of their respective owners.

Legal Disclaimer

TO THE MAXIMUM EXTENT PERMITTED BY APPLICABLE LAW, THE PRODUCT DESCRIBED, WITH ITS HARDWARE, SOFTWARE AND FIRMWARE, IS PROVIDED "AS IS", WITH ALL FAULTS AND ERRORS, AND HIKVISION MAKES NO WARRANTIES, EXPRESS OR IMPLIED, INCLUDING WITHOUT LIMITATION, MERCHANTABILITY, SATISFACTORY QUALITY, FITNESS FOR A PARTICULAR PURPOSE, AND NON-INFRINGEMENT OF THIRD PARTY. IN NO EVENT WILL HIKVISION, ITS DIRECTORS, OFFICERS, EMPLOYEES, OR AGENTS BE LIABLE TO YOU FOR ANY SPECIAL, CONSEQUENTIAL, INCIDENTAL, OR INDIRECT DAMAGES, INCLUDING, AMONG OTHERS, DAMAGES FOR LOSS OF BUSINESS PROFITS, BUSINESS INTERRUPTION, OR LOSS OF DATA OR DOCUMENTATION, IN CONNECTION WITH THE USE OF THIS PRODUCT, EVEN IF HIKVISION HAS BEEN ADVISED OF THE POSSIBILITY OF SUCH DAMAGES.

REGARDING TO THE PRODUCT WITH INTERNET ACCESS, THE USE OF PRODUCT SHALL BE WHOLLY AT YOUR OWN RISKS. HIKVISION SHALL NOT TAKE ANY RESPONSIBILITIES FOR ABNORMAL OPERATION, PRIVACY LEAKAGE OR OTHER DAMAGES RESULTING FROM CYBER ATTACK, HACKER ATTACK, VIRUS INSPECTION, OR OTHER INTERNET SECURITY RISKS; HOWEVER, HIKVISION WILL PROVIDE TIMELY TECHNICAL SUPPORT IF REQUIRED.

SURVEILLANCE LAWS VARY BY JURISDICTION. PLEASE CHECK ALL RELEVANT LAWS IN YOUR JURISDICTION BEFORE USING THIS PRODUCT IN ORDER TO ENSURE THAT YOUR USE CONFORMS THE APPLICABLE LAW. HIKVISION SHALL NOT BE LIABLE IN THE EVENT THAT THIS PRODUCT IS USED WITH ILLEGITIMATE PURPOSES.

IN THE EVENT OF ANY CONFLICTS BETWEEN THIS MANUAL AND THE APPLICABLE LAW, THE LATER PREVAILS.

Regulatory Information

FCC Information

Please take attention that changes or modification not expressly approved by the party responsible for compliance could void the user's authority to operate the equipment.

FCC compliance: This equipment has been tested and found to comply with the limits for a Class B digital device, pursuant to part 15 of the FCC Rules. These limits are designed to provide reasonable protection against harmful interference in a residential installation. This equipment generates, uses and can radiate radio frequency energy and, if not installed and used in accordance with the instructions, may cause harmful interference to radio communications. However, there is no guarantee that interference will not occur in a particular installation. If this equipment does cause harmful interference to radio or television reception, which can be determined by turning the equipment off and on, the user is encouraged to try to correct the interference by one or more of the following measures:

- Reorient or relocate the receiving antenna.
- Increase the separation between the equipment and receiver.
- Connect the equipment into an outlet on a circuit different from that to which the receiver is connected.
- Consult the dealer or an experienced radio/TV technician for help.

FCC Conditions

This device complies with part 15 of the FCC Rules. Operation is subject to the following two conditions:

1. This device may not cause harmful interference.
2. This device must accept any interference received, including interference that may cause undesired operation.

EU Conformity Statement



This product and - if applicable - the supplied accessories too are marked with "CE" and comply therefore with the applicable harmonized European standards listed under the EMC Directive 2014/30/EU, the RoHS Directive 2011/65/EU.



2012/19/EU (WEEE directive): Products marked with this symbol cannot be disposed of as unsorted municipal waste in the European Union. For proper recycling, return this product to your local supplier upon the purchase of equivalent new equipment, or dispose of it at designated collection points. For more information see:

www.recyclethis.info



2006/66/EC (battery directive): This product contains a battery that cannot be disposed of as unsorted municipal waste in the European Union. See the product documentation for specific battery information. The battery is marked with this symbol, which may include lettering to indicate cadmium (Cd), lead (Pb), or mercury (Hg). For proper recycling, return the battery to your supplier or to a designated collection point. For more information see: www.recyclethis.info

Industry Canada ICES-003 Compliance

This device meets the CAN ICES-3 (B)/NMB-3(B) standards requirements.



Safety Instruction

These instructions are intended to ensure that user can use the product correctly to avoid danger or property loss.

The precaution measure is divided into “Warnings” and “Cautions”

Warnings: Serious injury or death may occur if any of the warnings are neglected.

Cautions: Injury or equipment damage may occur if any of the cautions are neglected.

	
<p>Warnings Follow these safeguards to prevent serious injury or death.</p>	<p>Cautions Follow these precautions to prevent potential injury or material damage.</p>



Warnings

- Proper configuration of all passwords and other security settings is the responsibility of the installer and/or end-user.
- In the use of the product, you must be in strict compliance with the electrical safety regulations of the nation and region. Please refer to technical specifications for detailed information.

- Input voltage should meet both the SELV (Safety Extra Low Voltage) and the Limited Power Source with 24 VAC or 12 VDC according to the IEC60950-1 standard. Please refer to technical specifications for detailed information.
- Do not connect several devices to one power adapter as adapter overload may cause over-heating or a fire hazard.
- Please make sure that the plug is firmly connected to the power socket. When the product is mounted on wall or ceiling, the device shall be firmly fixed.
- If smoke, odor or noise rise from the device, turn off the power at once and unplug the power cable, and then please contact the service center.



Cautions

- Make sure the power supply voltage is correct before using the camera.
- Do not drop the camera or subject it to physical shock.
- Do not touch sensor modules with fingers. If cleaning is necessary, use clean cloth with a bit of ethanol and wipe it gently. If the camera will not be used for an extended period, please replace the lens cap to protect the sensor from dirt.
- Do not aim the camera at the sun or extra bright places. Blooming or smearing may occur otherwise (which is not a malfunction), and affect the endurance of sensor at the same time.

Network Bullet Camera • Quick Start Guide

- The sensor may be burned out by a laser beam, so when any laser equipment is in using, make sure that the surface of sensor will not be exposed to the laser beam.
- Do not place the camera in extremely hot, cold (the operating temperature shall be -30°C to +60°C, or -40°C to 60°C if the camera model has an “H” in its suffix), dusty or damp locations, and do not expose it to high electromagnetic radiation.
- To avoid heat accumulation, good ventilation is required for operating environment.
- Keep the camera away from liquid while in use.
- While in delivery, the camera shall be packed in its original packing, or packing of the same texture.
- Regular part replacement: a few parts (e.g. electrolytic capacitor) of the equipment shall be replaced regularly according to their average enduring time. The average time varies because of differences between operating environment and using history, so regular checking is recommended for all the users. Please contact with your dealer for more details.
- Improper use or replacement of the battery may result in hazard of explosion. Replace with the same or equivalent type only. Dispose of used batteries according to the instructions provided by the battery manufacturer.
- If the product does not work properly, please contact your dealer or the nearest service center. Never attempt to disassemble the camera yourself. (We shall not assume any responsibility for problems caused by unauthorized repair or maintenance.)

0504501070109

Table of Contents

1 Appearance Description	10
1.1 Type I Camera	10
1.2 Type II Camera	11
1.3 Type III Camera	13
1.4 Type IV Camera	15
1.5 Type V Camera	17
2 Installation	19
2.1 Memory Card Installation.....	19
2.2 Type I Camera Mounting	22
2.2.1 Wall Mounting.....	22
2.2.2 Pendant Mounting	24
2.3 Other Types Camera Mounting	27
2.3.1 Direct Mounting	27
2.3.2 Mounting with a Junction Box	30
2.3.3 Mounting with a Gang Box	31
2.4 Zoom and Focus Adjustment	32
2.4.1 Type I, Type II and Type IV	32
2.4.2 Type III and Type V	34
2.5 Installation of Network Cable Water-proof Jacket (Optional)	34
3 Setting the Network Camera over the LAN	37
3.1 Wiring	37
3.2 Activating the Camera	38
3.2.1 Activation via Web Browser.....	38
3.2.2 Activation via SADP Software	39
3.3 Modifying the IP Address	41

4 Accessing via Web Browser	44
5 Operating via Hik-Connect App	46
5.1 Enable Hik-Connect Service on Camera	46
5.1.1 Enable Hik-Connect Service via SADP Software ..	46
5.1.2 Enable Hik-Connect Service via Web Browser	47
5.2 Hik-Connect Setup	49
5.3 Adding Camera to Hik-Connect	49
5.4 Initializing the Memory Card	51

1 Appearance Description

1.1 Type I Camera

The overview of Type I camera is shown below.

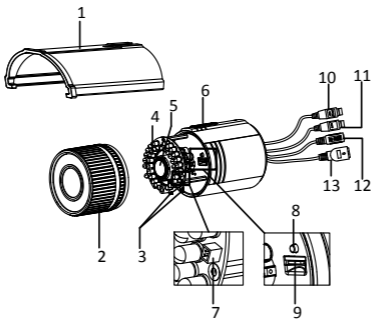

Figure 1-1 Overview of Type I Camera

Table 1-1 Description

No.	Description
1	Sun Shield
2	Front Cover
3	Zoom and Focus Lever
4	IR LED

No.	Description
5	Lens
6	Air Vent
7	Video Output Interface
8	Reset Button
9	Memory Card Slot
10	Audio Cable
11	Alarm Cable
12	Power Cord
13	Network Cable

Note:

Press RESET about 10s when the camera is powering on or rebooting to restore the default settings, including the user name, password, IP address, port No., etc.

1.2 Type II Camera

The overview of Type II camera is shown below.

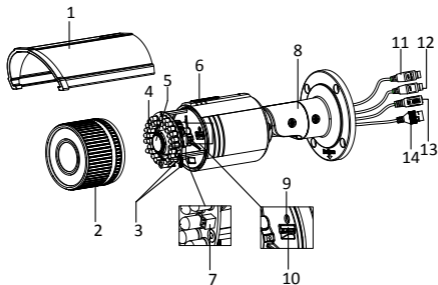

Figure 1-2 Overview of Type II Camera (1)

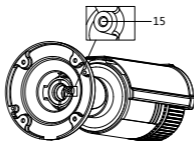

Figure 1-3 Overview of Type II Camera (2)

Table 1-2 Description

No.	Description
1	Sun Shield
2	Front Cover
3	Zoom and Focus Lever

No.	Description
4	IR LED
5	Lens
6	Air Vent
7	Video Output Interface
8	Bracket
9	Reset Button
10	Memory Card Slot
11	Audio Cable
12	Alarm Cable
13	Power Cord
14	Network Cable
15	Grounding

Note:

Press RESET about 10s when the camera is powering on or rebooting to restore the default settings, including the user name, password, IP address, port No., etc.

1.3 Type III Camera

The overview of Type III camera is shown below.

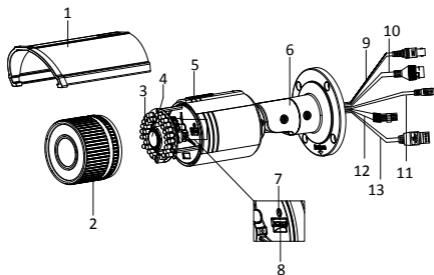

Figure 1-4 Overview of Type III Camera (1)

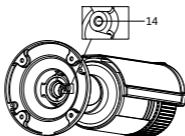

Figure 1-5 Overview of Type III Camera (2)

Table 1-3 Description

No.	Description
1	Sun Shield
2	Front Cover
3	IR LED

No.	Description
4	Lens
5	Air Vent
6	Bracket
7	Reset Button
8	Memory Card Slot
9	Video Cable
10	Network Cable
11	Power Cord
12	Alarm Cable
13	Audio Cable
14	Grounding

Note:

Press RESET about 10s when the camera is powering on or rebooting to restore the default settings, including the user name, password, IP address, port No., etc.

1.4 Type IV Camera

The overview of Type IV camera is shown below.

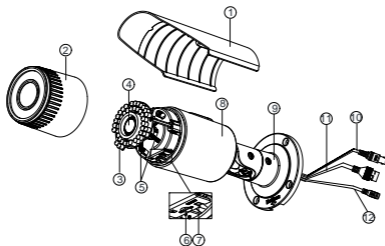

Figure 1-6 Overview of Type IV Camera

Table 1-4 Description

No.	Description
1	Sun Shield
2	Front Cover
3	IR LED
4	Lens
5	Zoom and Focus Lever
6	Memory Card Slot
7	Reset Button
8	Camera Body
9	Bracket

No.	Description
10	Video Cable
11	Network Cable
12	Power Cord

Note:

Press RESET about 10s when the camera is powering on or rebooting to restore the default settings, including the user name, password, IP address, port No., etc.

1.5 Type V Camera

The overview of Type V camera is shown below.

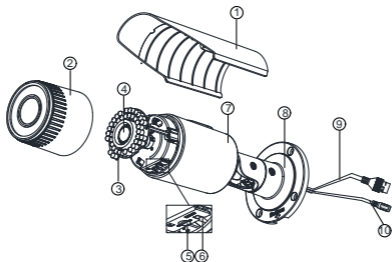

Figure 1-7 Overview of Type V Camera

Table 1-5 Description

Network Bullet Camera • Quick Start Guide

No.	Description
1	Sun Shield
2	Front Cover
3	IR LED
4	Lens
5	Memory Card Slot
6	Reset Button
7	Camera Body
8	Bracket
9	Network Cable
10	Power Cord

Note:

Press RESET about 10s when the camera is powering on or rebooting to restore the default settings, including the user name, password, IP address, port No., etc.

2 Installation

Before you start:

- Make sure the device in the package is in good condition and all the assembly parts are included.
- The standard power supply is 12V DC or PoE (802.3af). Make sure your power supply matches with your camera.
- Make sure all the related equipment is power-off during the installation.
- Check the specification of the products for the installation environment.
- Make sure that the wall is strong enough to withstand four times the weight of the camera and the bracket.

For the camera that supports IR, you are required to pay attention to the following precaution to prevent IR reflection:

- Make sure that there is no reflective surface too close to the camera lens. The IR light from the camera may reflect back into the lens causing reflection.

2.1 Memory Card Installation

This series of cameras support memory card installation. Different camera types share the similar installation steps, and we take type I camera as the example.

Steps:

1. Rotate the lock screw counterclockwise to loosen it.

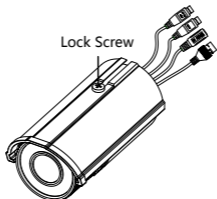

Figure 2-1 Loosen the Lock Screw

2. Remove the sun shield.

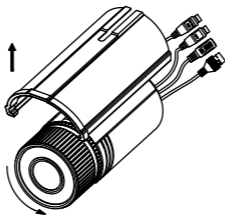

Figure 2-2 Remove the Sun Shield

3. Remove the front cover by rotating it counterclockwise.
4. Insert the memory card into the memory card slot.

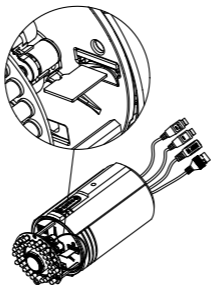

Figure 2-3 Insert the Memory Card

5. Rotate the front cover clockwise back to the camera and install the sun shield back.
6. Tighten the lock screw clockwise to tighten the sun shield.

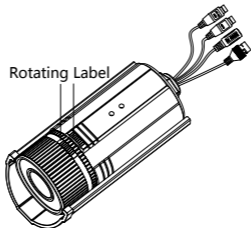

Figure 2-4 Tighten the Front Cover

Note:

For water-proof performance, align the rotating label on the front cover with that on the camera when you rotate the front cover clockwise.

2.2 Type I Camera Mounting

2.2.1 Wall Mounting

Before you start:

Wall mounting bracket is not included in the package. You need to purchase a bracket separately.

Steps:

1. Install the wall mounting bracket to the wall with the supplied screws.

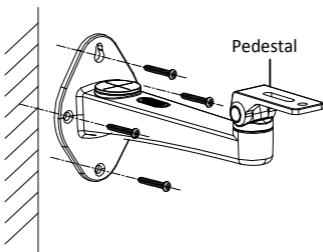

Figure 2-5 Install the Wall Mounting Bracket

Note:

Insert the expansion screws first if the camera is mounted to a cement wall. And you can use the self-tapping screws directly if the camera is mounted to a wooden wall.

2. Align the camera to the pedestal of the bracket, and fix the camera with the supplied screws.

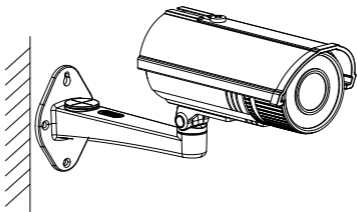

Figure 2-6 Install the Camera to the Bracket

3. Adjust the view angle.
 - 1). Loosen the pan adjusting screw to adjust the panning position from 0° to 360°. Tighten the screw.
 - 2). Loosen the tilt adjusting screw to adjust the tilting position from 0° to 90°. Tighten the screw.

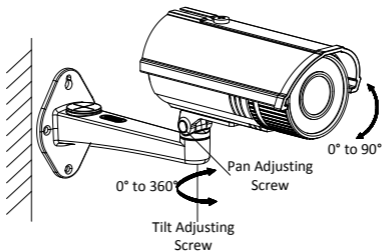

Figure 2-7 Adjust View Angle

4. Adjust zoom and focus (refer to **Section 2.4 Zoom and Focus Adjustment**).
5. (Optional) Install the water-proof jacket for network interface. Refer to **Section 2.5 Installation of Network Cable Water-proof Jacket (Optional)** for detailed installation procedures.

2.2.2 Pendant Mounting

Before you start:

Pendant bracket is not included in the package. You need to purchase a bracket separately.

Steps:

1. Fix the pendant bracket to the ceiling with the supplied screws.

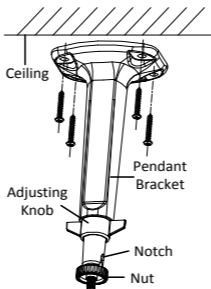

Figure 2-8 Fix the Pendant Bracket

2. Loosen and remove the lock screw on the sun shield of the camera.
3. Screw the camera to the pendant bracket through the lock screw hole. Tighten the nut to secure the camera.

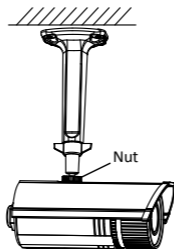

Figure 2-9 Secure the Camera

4. Adjust the view angle as shown in Figure 2-10.
 - 1). Loosen the adjusting knob.
 - 2). Rotate the notch to face or be back to your surveillance scene according to your actual need.

Note:

To obtain larger angel adjustment range, place the notch back to the surveillance scene if your camera monitors downwards, and place the notch facing the surveillance scene if your camera monitors upwards.

- 3). Adjust panning position from 0° to 360° .
- 4). Adjust tilting position from 0° to 90° .
- 5). Tighten the adjusting knob.

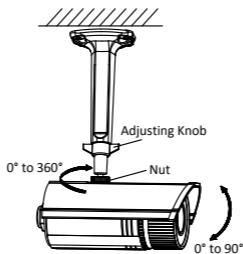

Figure 2-10 Adjust the View Angle

5. Adjust zoom and focus (refer to **Section 2.4 Zoom and Focus Adjustment**).

6. (Optional) Install the water-proof jacket for network interface.
Refer to **Section 2.5 Installation of Network Cable Water-proof Jacket (Optional)** for detailed installation procedures.

2.3 Other Types Camera Mounting

Before you start:

Camera of these types is equipped with a bracket. It can be mounted to a wall or a ceiling directly and can also be mounted with a junction box or a gang box.

2.3.1 Direct Mounting

Steps:

1. Attach the drill template (supplied) to the wall or the ceiling where the camera is to be mounted.
2. Drill screw holes in the wall or ceiling according to the hole 1 on the drill template.

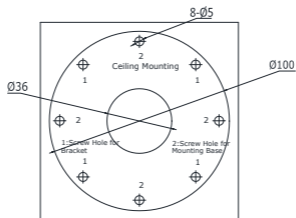

Figure 2-11 Drilling Holes in the Wall/Ceiling

3. If you need to route cables through the wall (or the ceiling), cut a cable hole according to the drill template. Skip this step if you want to route the cables on the surface of the wall (or the ceiling).
4. Route the cables of the camera.
5. Secure the camera to the wall (or the ceiling) with the expansion screws.

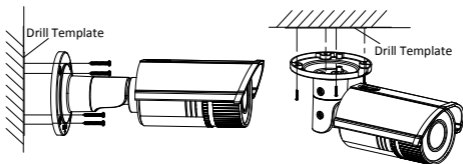

Figure 2-12 Secure the Camera

6. Adjust the view angle.
3-axis (pan/tilt/rotation) adjusting allows adjustment for optimum camera rotation and placement. Follow the steps below to adjust the view angle.

Pan Adjustment

Steps:

- 1). Loosen the lock screw 1.
- 2). Adjust the panning position of the camera. The adjusting range is from 0° to 360°.
- 3). Tighten the lock screw 1.

Tilt Adjustment

Steps:

- 1). Loosen the lock screw 2.
- 2). Adjust the tilting position of the camera. The adjusting range is from 0° to 100°.
- 3). Tighten the lock screw 2.

Rotation Adjustment

Steps:

- 1). Loosen the lock screw 3.
- 2). Rotate the rotation position to adjust the azimuth angle of the image. The adjusting range is from 0° to 360°.
- 3). Tighten the lock screw 3.

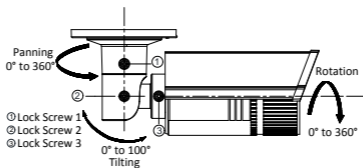

Figure 2-13 View Angle Adjustment

7. Adjust zoom and focus (refer to **Section 2.4 Zoom and Focus Adjustment**).
8. (Optional) Install the water-proof jacket for network interface. Refer to **Section 2.5 Installation of Network Cable Water-proof Jacket (Optional)** for detailed installation procedures.

2.3.2 Mounting with a Junction Box

Before you start:

The junction box is not included in the package. You need to prepare one for this mounting type.

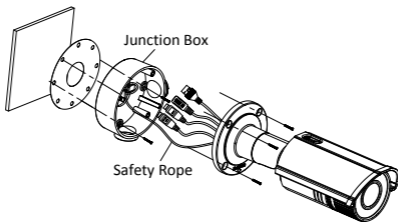

Figure 2-14 Mounting with a Junction Box

Steps:

1. Attach the drill template (supplied) to the wall where the camera is to be mounted and drill holes in the wall according to hole 2 on the drill template. See Figure 2-11.
2. If you need to route cables through the wall (or the ceiling), cut a cable hole according to the drill template. Skip this step if you want to route the cables on the surface of the wall (or the ceiling).
3. Secure the junction box to the wall (or the ceiling) with the expansion screws.
4. Hook the camera to the junction box with the safety rope.

- (Optional) Install the water-proof jacket for network interface. Refer to **Section 2.5 Installation of Network Cable Water-proof Jacket (Optional)** for detailed installation procedures.
- Route the cables of the camera. Connect the interfaces to the power on the camera to see if you can get an image on your monitoring screen.
Note:
If you can't get the image, check the power and network connection before performing the next step.
- Secure the camera to the junction box with the screws.
- Adjust the view angle. Refer to Step 6 in **Section 2.3.1 Direct Mounting**.
- Adjust zoom and focus (refer to **Section 2.4 Zoom and Focus Adjustment**).

2.3.3 Mounting with a Gang Box

Before you start:

The gang box is not included in the package. You need to prepare one for this mounting type.

Steps:

- Secure the camera attachment to a gang box with the screws.
- (Optional) Install the water-proof jacket for network interface. Refer to **Section 2.5 Installation of Network Cable Water-proof Jacket (Optional)** for detailed installation procedures.
- Route the cables of the camera.

4. Connect the interfaces to the power on the camera to see if you can get an image on you monitoring screen.

Note:

If you can't get the image, check the connection of the interfaces before performing the next step.

5. Secure the camera to the camera attachment with the screws.

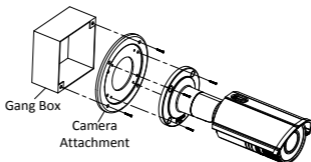

Figure 2-15 Mounting with a Gang Box

7. Adjust the view angle. Refer to Step 6 in **Section 2.3.1 Direct Mounting**.
8. Adjust zoom and focus (refer to **Section 2.4 Zoom and Focus Adjustment**).

2.4 Zoom and Focus Adjustment

2.4.1 Type I, Type II and Type IV

Purpose:

You can use the zoom lever and focus lever to adjust the zoom and focus level. Follow the steps below to adjust focus and zoom. We take type II camera as the example to explain the adjusting steps.

Steps:

1. Remove the sun shield and front cover to expose the zoom lever and the focus lever.
2. View the camera image on the monitoring screen.
3. Loosen the zoom lever and move the lever between T (Tele) and W (Wide) to obtain the desired angle of view.
4. Tighten the zoom lever.
5. Loosen the focus lever and move the lever between F (Far) and N (Near) to obtain the optimum focus.
6. Tighten the focus lever.
7. Install the sun shield and the front cover back to the camera.

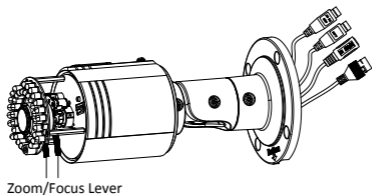

Figure 2-16 Zoom and Focus Adjustment

Note:

If the camera is equipped with a fixed lens, you don't need to adjust the zoom and focus.

2.4.2 Type III and Type V

Camera of these types is equipped with a motorized vari-focal lens. You can adjust the zoom and focus level on PTZ control panel by visiting the camera via web browser or client software.

For detailed steps, refer to the *User Manual of Network Camera*.



Figure 2-17 Zoom and Focus Adjustment via Web Browser

2.5 Installation of Network Cable Water-proof Jacket (Optional)

Purpose:

If the camera is installed outdoor, you can adopt the water-proof accessory for the network cable after the camera is secured on the installation surface.

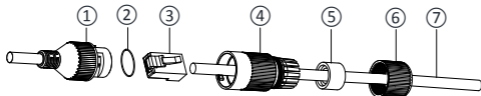

Figure 2-18 Water-proof Accessory Components

Table 2-1 Components

No.	Components
1	Network Interface Socket
2	O-Type Gasket
3	Network Plug
4	Waterproof Endcap
5	Waterproof Rubber Gasket
6	Lock Nut
7	Network Cable from Router/Switch

Steps:

- 1) Feed the plugless network cable ⑦ through the lock nut ⑥, waterproof rubber gasket ⑤ (the rubber gasket inset ridge must face the waterproof endcap), and the waterproof endcap ④ in order.
- 2) Crimp an RJ-45 network plug ③ onto the end of the cable, taking care to insert the twisted pairs of wires in correct order.
- 3) Place the O-type gasket ② onto the end of the camera's network interface socket ①.
- 4) Insert the network plug ③ into the camera's network interface socket ①.

- 5) Insert the waterproof rubber gasket (5) into the waterproof endcap (4), and secure lock nut (6) with the waterproof endcap (4).
- 6) Align the snap on the waterproof endcap (4) with the notch on the camera's network interface socket (1), and then secure the waterproof endcap (4) to the camera's network interface socket (1) to finish installation.

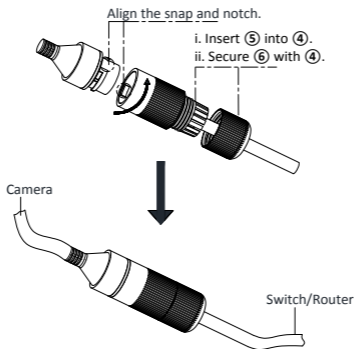

Figure 2-19 Water-proof Accessory Installation

3 Setting the Network Camera over the LAN

Note:

You shall acknowledge that the use of the product with Internet access might be under network security risks. For avoidance of any network attacks and information leakage, please strengthen your own protection.

If the product does not work properly, contact your dealer or the nearest service center for help.

3.1 Wiring

Connect the camera to network according to the following figures.

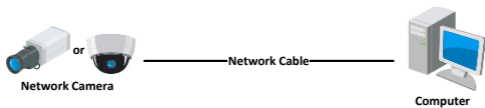

Figure 3-1 Connecting Directly

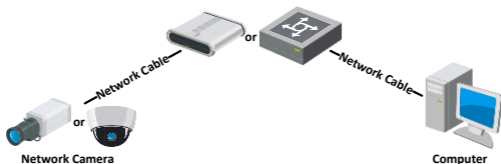

Figure 3-2 Connecting via a Switch or a Router

3.2 Activating the Camera

You are required to activate the camera first by setting a strong password for it before you can use the camera.

Activation via Web Browser, Activation via SADP, and Activation via Client Software are all supported. We will take activation via SADP software and Activation via Web Browser as examples to introduce the camera activation.

Note:

Refer to the User Manual of Network Camera for Activation via Client Software.

3.2.1 Activation via Web Browser

Steps:

1. Power on the camera. Connect the camera to your computer or the switch/router which your computer connects to.
2. Input the IP address into the address bar of the web browser, and press Enter to enter the activation interface.

Notes:

- The default IP address of the camera is 192.168.1.64.
- The computer and the camera should belong to the same subnet.
- For the camera enables the DHCP by default, you need to use the SADP software to search the IP address.

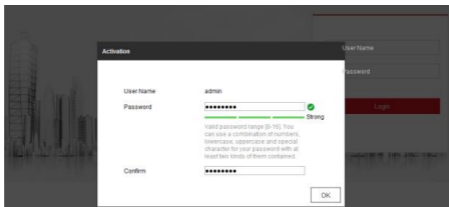

Figure 3-3 Activation Interface(Web)

3. Create a password and input the password into the password field.



STRONG PASSWORD RECOMMENDED– *We highly recommend you create a strong password of your own choosing (using a minimum of 8 characters, including upper case letters, lower case letters, numbers, and special characters) in order to increase the security of your product. And we recommend you reset your password regularly, especially in the high security system, resetting the password monthly or weekly can better protect your product.*

4. Confirm the password.
5. Click **OK** to save the password and enter the live view interface.

3.2.2 Activation via SADP Software

SADP software is used for detecting the online device, activating the camera, and resetting the password.

Network Bullet Camera • Quick Start Guide

Get the SADP software from the supplied disk or the official website, and install the SADP according to the prompts.

Follow the steps to activate the camera.

Steps:

1. Run the SADP software to search the online devices.
2. Check the device status from the device list, and select the inactive device.

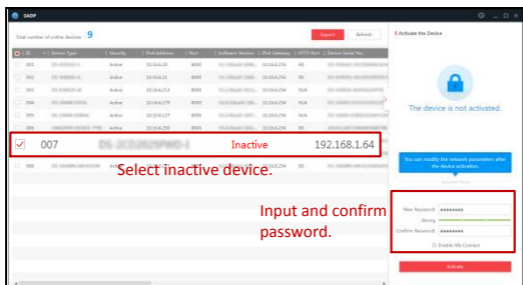

Figure 3-4 SADP Interface

Note:

The SADP software supports activating the camera in batch. Refer to the user manual of SADP software for details.

3. Create and input the new password in the password field, and confirm the password.



STRONG PASSWORD RECOMMENDED– *We highly recommend you create a strong password of your own choosing (using a minimum of 8 characters, including upper case letters, lower case letters, numbers, and special characters) in order to increase the security of your product. And we recommend you reset your password regularly, especially in the high security system, resetting the password monthly or weekly can better protect your product.*

Note:

You can enable the Hik-Connect service for the device during activation. Refer to Chapter 5.1 for detailed information.

4. Click **Activate** to start activation.

You can check whether the activation is completed on the popup window. If activation failed, make sure that the password meets the requirement and try again.

3.3 Modifying the IP Address

Purpose:

To view and configure the camera via LAN (Local Area Network), you need to connect the network camera in the same subnet with your PC.

Use the SADP software or client software to search and change the IP address of the device. We take modifying the IP Address via SADP software as an example to introduce the IP address modification.

For IP address modification via client software, refer to the user manual of client software.

Steps:

1. Run the SADP software.
2. Select an active device.
3. Change the device IP address to the same subnet with your computer by either modifying the IP address manually or checking the checkbox of Enable DHCP.

Modify Network Parameters

Enable DHCP
 Enable Hik-Connect

Device Serial No.:

IP Address:

Port:

Subnet Mask:

Gateway:

IPv6 Address:

IPv6 Gateway:

IPv6 Prefix Length:

HTTP Port:

Security Verification

Admin Password:

Modify

[Forgot Password](#)

Figure 3-5 Modify the IP Address

Note:

You can enable the Hik-Connect service for the device during activation. Refer to Chapter 5.1 for detailed information.

4. Input the admin password and click **Modify** to activate your IP address modification.

The batch IP address modification is supported by the SADP. Refer to the user manual of SADP for details.

4 Accessing via Web Browser

System Requirement:

Operating System: Microsoft Windows XP SP1 and above version

CPU: 2.0 GHz or higher

RAM: 1G or higher

Display: 1024×768 resolution or higher

Web Browser: Internet Explorer 8.0 and above version, Apple Safari 5.0.2 and above version, Mozilla Firefox 5.0 and above version and Google Chrome 18 and above version

Steps:

1. Open the web browser.
2. In the browser address bar, input the IP address of the network camera, and press the **Enter** key to enter the login interface.

Note:

- The default IP address is 192.168.1.64. You are recommended to change the IP address to the same subnet with your computer.

3. Input the user name and password.

The admin user should configure the device accounts and user/operator permissions properly. Delete the unnecessary accounts and user/operator permissions.

Note:

The device IP address gets locked if the admin user performs 7 failed password attempts (5 attempts for the user/operator).

4. Click **Login**.



Figure 4-1 Login Interface

5. Install the plug-in before viewing the live video and managing the camera. Follow the installation prompts to install the plug-in.

Note:

You may have to close the web browser to finish the installation of the plug-in.

[Please click here to download and install the plug-in. Close the browser when installing the plug-in.](#)

Figure 4-2 Download Plug-in

6. Reopen the web browser after the installation of the plug-in and repeat steps 2 to 4 to login.

Note:

For detailed instructions of further configuration, please refer to the user manual of network camera.

5 Operating via Hik-Connect App

Purpose:

Hik-Connect is an application for mobile devices. With the App, you can view live image of the camera, receive alarm notification and so on.

Note:

Hik-Connect service is not supported by certain camera models.

5.1 Enable Hik-Connect Service on Camera

Purpose:

Hik-Connect service should be enabled on your camera before using the service.

You can enable the service through SADP software or web browser.

5.1.1 Enable Hik-Connect Service via SADP Software

Steps:

1. Check the checkbox of **Enable Hik-Connect** on:
 - 1). "Activate the Device" page during camera activation, refer to Chapter 3.2.2.
 - 2). Or "Modify Network Parameters" page during modifying IP address, refer to Chapter 3.3.
2. Create a verification code or change the verification code.

The screenshot shows a dialog box titled "Tips" with a red header and a close button (X) in the top right corner. The main content area is white and contains the following text:

To enable Hik-Connect service, you need to create a verification code or change the verification code.

Verification Code

6 to 12 letters or numbers, case sensitive. You are recommended to use a combination of no less than 8 letters or numbers.

Confirm Verification Code

The Hik-Connect service will require internet access. Please read the ["Terms of Service"](#) and ["Privacy Policy"](#) before enabling the service.

At the bottom right, there are two buttons: "Confirm" (red) and "Cancel" (white).

Figure 5-1 Verification Code Setting (SADP)

Note:

The verification code is required when you add the camera to Hik-Connect app.

3. Click and read "Terms of Service" and "Privacy Policy".
4. Confirm the settings.

5.1.2 Enable Hik-Connect Service via Web Browser

Before you start:

You need to activate the camera before enabling the service. Refer to Chapter 3.2.

Steps:

1. Access the camera via web browser. Refer to Chapter 4.
2. Enter platform access configuration interface: Configuration > Network > Advanced Settings > Platform Access

Enable

Platform Access Mode

Server IP Custom

Register Status

Verification Code

6 to 12 letters (a to z, A to Z) or numbers (0 to 9), case sensitive. You are recommended to use

Figure 5-2 Platform Access Configuration (Web)

3. Select Platform Access Mode as Hik-Connect.
4. Check the checkbox of Enable.
5. Click and read "Terms of Service" and "Privacy Policy" in pop-up window.
6. Create a verification code or change the verification code for the camera.

Note:

The verification code is required when you add the camera to Hik-Connect app.

7. Save the settings.

5.2 Hik-Connect Setup

Steps:

1. Download and install the Hik-Connect app by searching “Hik-Connect” in App Store or Google Play™.
2. Launch the app and register for a Hik-Connect user account.
3. Log in Hik-Connect app after registration.

5.3 Adding Camera to Hik-Connect

Before you start:

You need to enable the Hik-Connect service on camera before adding it to your Hik-Connect account. Refer to Chapter 5.1.

Steps:

1. Use a network cable to connect the camera with a router if the camera does not support Wi-Fi.



Figure 5-3 Connect a Router

Note:

After the camera connects to the network, please wait one minute before any operation on the camera using Hik-Connect app.

2. In the Hik-Connect app, tap “+” on the upper-right corner and then scan the QR code of the camera to add the camera.

You can find the QR code on the camera or on the cover of the Quick Start Guide of the camera in the package.

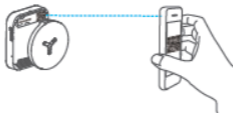



Figure 5-4 Scan QR Code

Note:

If the QR code is missing or too blur to be recognized, you can also add the camera by tapping the  icon and inputting the camera's serial number.

3. Input the verification code of your camera.

Note:

- The required verification code is the code you create or change when you enabling Hik-Connect service on camera.
- If you forget the verification code, you can check the current verification code on **Platform Access** configuration page via web browser.

4. Follow the prompts to set the network connection and add the camera to your Hik-Connect account.

Note:

For detailed information, refer to the user manual of the Hik-Connect app.

5.4 Initializing the Memory Card

Steps:

Check the memory card status by tapping on the Storage Status in the Device Settings interface.

If the memory card status displays as Uninitialized, tap to initialize it. The status will then change to Normal. You can then start recording any event triggered video in the camera such as motion detection.



First Choice for Security Professionals