

HIKVISION



HD WDR Box Camera

User Manual

UD.6L0201D1633A01

www.hikvision.com

Thank you for purchasing our product. If there are any questions, or requests, please do not hesitate to contact the dealer.

This manual may contain several technical incorrect places or printing errors, and the content is subject to change without notice. The updates will be added to the new version of this manual. We will readily improve or update the products or procedures described in the manual.

This manual applies to the DS-2CC12D9T (-A).

DISCLAIMER STATEMENT

Underwriters Laboratories Inc. (“UL”) has not tested the performance or reliability of the security or signaling aspects of this product. UL has only tested for fire, shock or casualty hazards as outlined in UL’s Standard(s) for Safety, UL60950-1. UL Certification does not cover the performance or reliability of the security or signaling aspects of this product. UL MAKES NO REPRESENTATIONS, WARRANTIES OR CERTIFICATIONS WHATSOEVER REGARDING THE PERFORMANCE OR RELIABILITY OF ANY SECURITY OR SIGNALING RELATED FUNCTIONS OF THIS PRODUCT.

0100001040917

Regulatory Information

FCC Information

FCC compliance: This equipment has been tested and found to comply with the limits for a digital device, pursuant to part 15 of the FCC Rules. These limits are designed to provide reasonable protection against harmful interference when the equipment is operated in a commercial environment. This equipment generates, uses, and can radiate radio frequency energy and, if not installed and used in accordance with the instruction manual, may cause harmful interference to radio communications. Operation of this equipment in a residential area is likely to cause harmful interference in which case the users will be required to correct the interference at their own expense.

FCC Conditions

This device complies with part 15 of the FCC Rules. Operation is subject to the following two conditions:

1. This device may not cause harmful interference.
2. This device must accept any interference received, including interference that may cause undesired operation

EU Conformity Statement



This product and - if applicable - the supplied accessories too are marked with "CE" and comply therefore with the applicable harmonized European standards listed under the Low Voltage Directive 2006/95/EC, the EMC Directive 2004/108/EC, the RoHS Directive 2011/65/EU.



Municipal waste in the European Union. For proper recycling, return this product to your local supplier upon the purchase of equivalent 2012/19/EU (WEEE directive): Products marked with this symbol cannot be disposed of as unsorted municipal waste in the European Union. For proper recycling, return this product to your local supplier upon the purchase of equivalent new equipment, or dispose of it at designated collection points. For more information, see: www.recyclethis.info.



2006/66/EC (battery directive): This product contains a battery that cannot be disposed of as unsorted municipal waste in the European Union. See the product documentation for specific battery information. The battery is marked with this symbol, which may include lettering to indicate cadmium (Cd), lead (Pb), or mercury (Hg). For proper recycling, return the battery to your supplier or to a designated collection point. For more information, see: www.recyclethis.info.



Safety Instruction

These instructions are intended to ensure that user can use the product correctly to avoid danger or property loss.

The precaution measure is divided into “Warnings” and “Cautions”

Warnings: Serious injury or death may occur if any of the warnings are neglected.

Cautions: Injury or equipment damage may occur if any of the cautions are neglected.

	
<p>Warnings Follow these safeguards to prevent serious injury or death.</p>	<p>Cautions Follow these precautions to prevent potential injury or material damage.</p>



Warnings

- In the use of the product, you must be in strict compliance with the electrical safety regulations of the nation and region.
- Please refer to technical specifications for detailed information.
- Input voltage should meet both the SELV (Safety Extra Low Voltage) and the Limited Power Source with AC 24V or DC 12V according to

the IEC60950-1 standard. Please refer to technical specifications for detailed information.

- Do not connect several devices to one power adapter as adapter overload may cause over-heating or a fire hazard.
- Please make sure that the plug is firmly connected to the power socket.
- When the product is mounted on wall or ceiling, the device shall be firmly fixed.
- If smoke, odor or noise rise from the device, turn off the power at once and unplug the power cable, and then please contact the service center.
- If the product does not work properly, please contact your dealer or the nearest service center. Never attempt to disassemble the camera yourself. (We shall not assume any responsibility for problems caused by unauthorized repair or maintenance.)



Cautions

- Make sure the power supply voltage is correct before using the camera.
- Do not drop the camera or subject it to physical shock.
- Do not touch sensor modules with fingers. If cleaning is necessary, use clean cloth with a bit of ethanol and wipe it gently. If the camera will not be used for an extended period, please replace the lens cap to protect the sensor from dirt.

- Do not aim the camera at the sun or extra bright places. Blooming or smearing may occur otherwise (which is not a malfunction), and affect the endurance of sensor at the same time.
- The sensor may be burned out by a laser beam, so when any laser equipment is in using, make sure that the surface of sensor will not be exposed to the laser beam.
- Do not place the camera in extremely hot, cold (the operating temperature shall be $(-10^{\circ}\text{C}\sim+60^{\circ}\text{C})$), dusty or damp locations, and do not expose it to high electromagnetic radiation.
- To avoid heat accumulation, good ventilation is required for operating environment.
- Keep the camera away from liquid while in use.
- While in delivery, the camera shall be packed in its original packing, or packing of the same texture.
- Improper use or replacement of the battery may result in hazard of explosion. Replace with the same or equivalent type only. Dispose of used batteries according to the instructions provided by the battery manufacturer.

Table of Contents

1 Introduction	8
1.1 Product Features	8
1.2 Overview	9
Overview of the Box Camera	9
2 Installation	12
2.1 Wall Mounting	12
2.2 Ceiling Mounting	18
3 Menu Description	20
3.1 VIDEO.OUT	21
3.2 LANGUAGE	21
3.3 SETUP	21
3.3.1 SMART FOCUS	21
3.3.2 SCENE	21
3.3.3 LENS	22
3.3.4 EXPOSURE	22
3.3.5 Backlight	26
3.3.6 White Balance (WB)	30
3.3.7 Day & Night	31
3.3.8 NR	32
3.3.9 SPECIAL	34
3.3.10 ADJUST	45
3.3.11 RESET	47
3.3.12 EXIT	47

1 Introduction

1.1 Product Features

This camera adopts high performance sensor and advanced print circuit board design technology. It possesses of high resolution, low distortion, and low noise features, etc. It is extremely suitable for surveillance system and image process system.

Main Features:

- Adopt high performance CMOS, and supply high definition and clear image;
- Low illumination 0.01Lux@(F1.2,AGC ON) , 0Lux with IR;
- Support ICR infrared filter auto switch;
- Support OSD menu controlling, enable user to configure the detailed parameters;
- Support 3D NR to get clear and fine image;
- Support wide dynamic range function;
- Support defogging function;
- Support auto white balance, auto gain control;
- Support coaxial camera controller.

1.2 Overview

Overview of the Box Camera

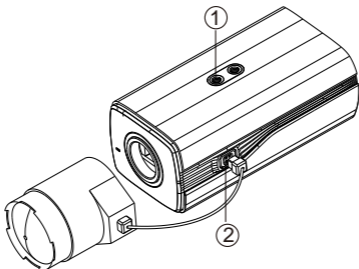

Figure 1-1 Overview of the Box Camera

Table 1-1 Description of the Box Camera

No.	Description
1	Lock screw
2	Auto-Iris Drive Interface

The Auto Iris Interface

The auto iris interface is composed of four square pins as shown in Figure 1-2.

Damp+, damp-, drive+ and drive- pins are used in DC driven mode.

	No.	DC
	1	Damp-
	2	Damp+
	3	Driver-
4	Driver+	

Figure 1-2 Pins of the Auto Iris Interface

Rear Panel

The rear panel of the box camera is shown as follows:

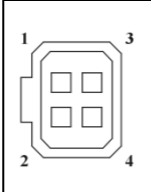
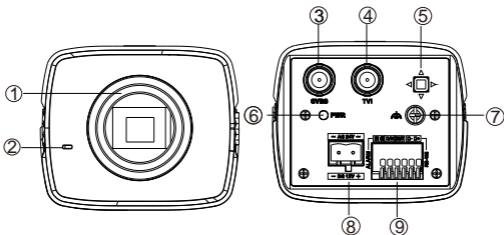

Figure 1-3 Panel Description of the Box Camera

Table 1-2 The Rear Panel Description

No.	Description	No.	Description
1	Lens	6	Power Indicator
2	Mic	7	Grounding Screw
3	Analog Video Output Interface	8	Power Interface
4	TVI Video Output Interface	9	Alarm OUT, IN, GND Interface
5	Joystick		

2 Installation

Before you start:

- Please make sure that the device in the package is in good condition and all the assembly parts are included.
- Make sure that all the related equipment is power-off during the installation.
- Check the specification of the products for the installation environment.
- Check whether the power supply is matched with your required output to avoid damage.
- Please make sure the wall or ceiling is strong enough to withstand three times the weight of the camera and the mounting.
- If the wall or ceiling is built by cement, you need to insert expansion screws before you install the camera. If the wall or ceiling is built by wooden, you can use self-tapping screw to secure the camera.
- If the product does not function properly, please contact your dealer or the nearest service center. Do not disassemble the camera for repair or maintenance by yourself.

2.1 Wall Mounting

Steps:

1. Rotate the lens clockwise onto the lens mount of the camera.

2. Plug the wire of auto iris lens to the auto iris interface of the camera.



- Please prevent dust from entering between the lens mount and the lens.
- The weight of the lens must be less than 1kg. It's better to install a lens with CS type interface. If the interface of lens is C type, you need to install a C adaptor between the lens and the camera.

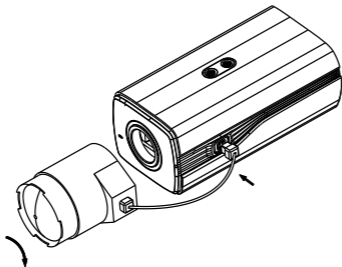

Figure 2-1 Fix the Camera on the Back-plane

3. Remove the back-plane from the camera housing. Attach the camera to the back-plane with supplied screws. As shown in Figure 2-2.

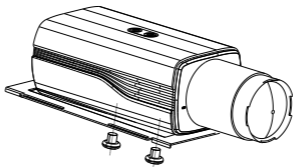

Figure 2-2 Fix the Back-plane in the housing

4. Fix the back-plane with the camera in the camera housing. As shown in Figure 2-3.

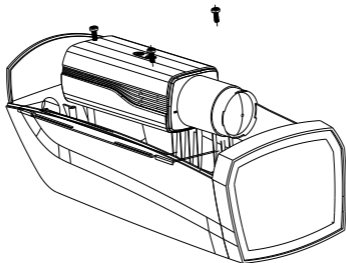

Figure 2-3 Fix the Camera in the Housing

5. Adjust the focal length of the lens and complete the focus adjustment.

- Move the zoom lever between T (Telephoto) and W (Wide angle) to obtain the appropriate angle of view.
- Move the focus lever between F (Far) and N (Near) to obtain the optimum focus.



In practical applications, you need to choose the corresponding lens according to the size of the sensor. The automatic iris lens will work at the maximum aperture mode.

6. Connect the camera with corresponding cables and route the cables through the cable hole on the bottom of the camera housing. Close and lock the camera housing.
7. Drill the screw holes on the wall according to the drill template. As shown in Figure 2-4.

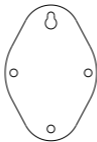

Figure 2-4 Mounting Template

8. Attach the wall mount to the wall and tighten the screws to fix it. As shown in Figure 2-5.

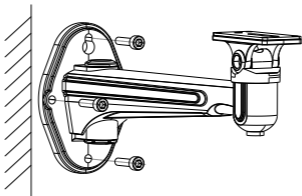

Figure 2-5 Install the Bracket



The wall mount (not provided) should be longer than 1/2 of the camera length.

9. Attach the camera with the housing to the wall mount and tighten the fix screw to fix the camera. As shown in Figure 2-6.

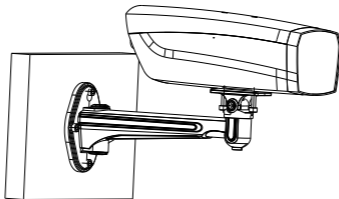

Figure 2-6 Fix the Camera Housing

10. Loosen the panning lock screw to adjust the panning angle of the camera. As shown in Figure 2-7.

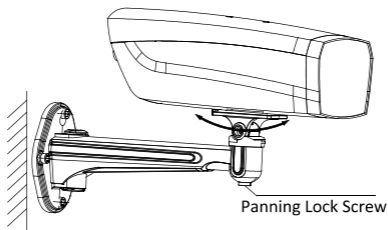

Figure 2-7 Adjust the Panning Angle

11. Loosen the tilting lock screw. You can adjust the tilting angle of the camera. As shown in Figure 2-8.

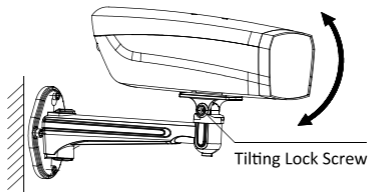

Figure 2-8 Adjust the Tilting Angle

2.2 Ceiling Mounting

Steps:

1. Drill the screw holes on the wall according to the drill template. As shown in Figure 2-9.

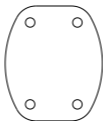

Figure 2-9 Mounting Template

2. Attach the ceiling mount to the wall and tighten the screws to fix it. As shown in Figure 2-10.

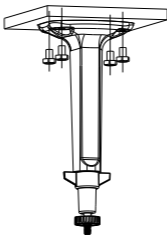

Figure 2-10 Install the Bracket

3. Attach the camera to the ceiling mount and tighten the fix screw to fix the camera. As shown in Figure 2-11.

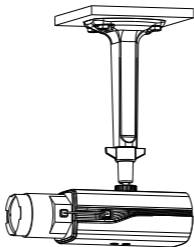

Figure 2-11 Fix the Camera Housing

4. Loosen the adjustable nut to adjust the panning angle and tilt angle of the camera.

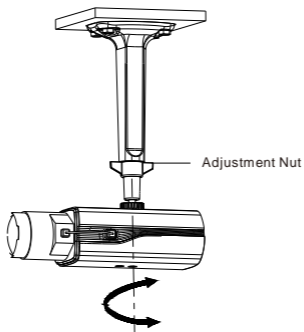

Figure 2-12 Angle Adjustment

3 Menu Description

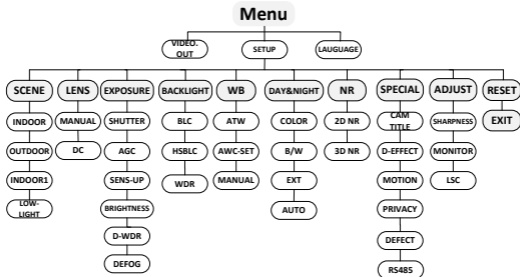

Figure 3-1 Main Menu Overview



- This series of camera adopts a joystick to select the menu and confirm a selection.
- Move the joystick up/down to select the menu item.
- Move the joystick left/right to adjust the value of the selected item.
- Press the joystick to confirm a selection. The menu button mentioned in the chapter below refers to the joystick.

3.1 VIDEO.OUT

Phase Alternating Lines (PAL) is a color encoding system for analog television used in broadcast television systems in most countries broadcasting at 576i.

National Television System Committee (NTSC) is the analog television system that is used in most of North America, parts of South America Myanmar, South Korea, etc.

Move the joystick left/right to select the required video output standard.

3.2 LANGUAGE

This series of camera supports multiple languages. English, Japanese, CHN1, CHN2, Korean, German, French, Italian, Spanish, Polish, Russian, Portuguese, Dutch, Turkish, Hebrew, and Arabic are selectable.

3.3 SETUP

3.3.1 SMART FOCUS

After completing the focus adjustment, enter the Smart Focus menu, and check the value displayed on the screen, the larger the value, the better the focus. Press the joystick again to exit the menu.

3.3.2 SCENE

Scene option allows user to select different working environments. Options of indoor, outdoor and low-light are selectable.

3.3.3 LENS

The lens of the camera can be selected as manual or DC. .

3.3.4 EXPOSURE

EXPOSURE	
1. SHUTTER	AUTO
2. AGC	OFF
3. SENS-UP	---
4. BRIGHTNESS	--- ----- 40
5. D-WDR	OFF
6. DEFOG	OFF
7. RETURN	RET

Figure 3-2 Exposure

Exposure describes the brightness-related parameters. You can adjust the image brightness by the SHUTTER, AGC, SENS-UP, BRIGHTNESS, ACCE, BACKLIGHT, etc. in different light conditions.

Shutter

Shutter denotes the speed of the shutter.

AUTO, 1/30, 1/60, FLK, 1/240, 1/480, 1/1k, 1/2k, 1/5k, 1/10k and 1/50k are selectable.



If you select shutter as **AUTO** or **1/30**, the SENS-UP is adjustable (**OFF/AUTO**), and the SENS-UP is disabled if any other shutter speed is selected.

AGC

It's a form of amplification where the camera will automatically boost the image received in much lower light conditions than standard in order to optimize the clarity of image in poor light scene. You can set the AGC value from **1** to **15**.



The noise will be amplified if the AGC is on.

SENS-UP



If you select shutter as **AUTO** or **1/30**, the SENS-UP is adjustable (**OFF/AUTO**), and the SENS-UP is disabled if any other shutter speed is selected.

SENS-UP increases the exposure on a signal frame, which makes a camera more sensitive to light so it can produce images even in low lux conditions. You can set the SENS-UP to **OFF** or **AUTO** according to different light conditions.

OFF: SENS-UP function is disabled.

AUTO: The SENS-UP function will automatically adjust itself to x2, x4, x6, x8, x10, x15, x20, x25, and x30 according to the different light conditions.

Brightness

Brightness refers to the brightness of the image. You can set the brightness value from 1 to 100 to darken or brighten the image. The higher the value is, the brighter the image is.

D-WDR

The digital wide dynamic range (D-WDR) function helps the camera provide clear images even under back light circumstances. When there are both very bright and very dark areas simultaneously in the field of view, D-WDR balances the brightness level of the whole image and provide clear images with details.

Set the D-WDR to **ON** to improve the image quality under the backlight environment.

Set the D-WDR to **OFF** to disable the function.

Defog

DEFOG is used in special environment such as the foggy or rainy weather or in high illumination, in which the dynamic range is lower than that in the ordinary environment and the image always appear hazy. Enable the defog function can enhance the subtle details so that the image appears clearer.

Set the defog function as **ON** to enable the function. Position, size, and the defog gradation are configurable.

DEFOG	
1. POS/SIZE	↵
2. GRADATION	LOW
3. DEFAULT	↵
4. RETURN	RET

Figure 3-3 Defog

Steps:

1. Move the cursor to **POS/SIZE**, and press **OK** to enter the position and size configuration interface.
2. Move the joystick up/down/right/left to define the position of the defog area.
3. Press **OK** again to switch the position configuration to the size configuration.
4. Move the joystick up/down/right/left to define the size of the defog area.
5. Press **OK** and select **RET** to return to the defog menu or select **AGAIN** to re-define the position and size.
6. (Optional) Move the cursor to **DEFAULT** and press **OK** to restore the defog settings to the default.

Low, middle and high are selectable for the defog gradation



Enabling the defog function will increase the contrast of the image. It is recommended that the defog function is set to OFF during the normal environment.

3.3.5 Backlight

Backlight is applicable for the backlight or the high luminance environment; you can set the Backlight to **OFF, BLC, WDR** and **HSBLC**.

Backlight Compensation (BLC)

If there's a strong backlight, the object in front of the backlight will appear silhouetted or dark. BLC bases on the back area to enhance the brightness of the whole image, which makes it possible to see the area before the strong backlight clearly, but the backlight area will be over-exposed.

BLC	
1. GAIN	MIDDLE
2. AREA	↕
3. DEFAULT	↕
4. RETURN	RET

Figure 3-4 BLC

The gain of BLC can be set to **High**, **Middle**, and **Low**, the higher the gain is, and the clearer the image is. Follow the steps below to set a BLC area.

Steps:

1. Move the cursor **AREA**, and press **OK** to enter the area edit interface.
2. Move the joystick up/down/left/right to define the BLC position.
3. Press **OK** to enter the area size edit interface.
4. Move the joystick up/down/left/right to define the BLC size.
5. Press **OK** to confirm the selection, and select **RET** to go back the BLC menu, or select **AGAIN** to re-define the BLC area.
6. (Optional) Move the cursor to **DEFAULT** and press **OK** to restore the BLC settings to the default.

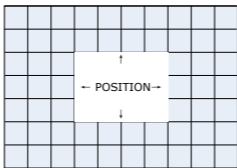

Figure 3-5 Define a BLC Area

HSBLC

HSBLC	
1. SELECT	AREA 1
2. DISPLAY	ON ↵
3. LEVEL	--- ----- 40
4. MODE	ALL DAY
5. BLACK MASK	ON
6. DEFAULT	↵
7. RETURN	RET

Figure 3-6 HSBLC

HSBLC masks strong light sources that usually flare across a scene. This makes it possible to see the detail of the image that would normally be hidden.

Steps:

1. Set the cursor right/left to select **HSBLC** and press **OK** to enter the edit interface.
2. Move the cursor to **SELECT** and select the area by setting the joystick to left/right. Four areas are selectable.
3. Set the **DISPLAY** to ON /OFF to enable/disable the HSBLC area.
4. Press **OK** to enter the position/size edit interface.
5. Move the joystick up/down/left/right to define the position of the HSBLC area.
6. Press **OK** to switch to the size edit interface.
7. Move the joystick up/down/left/right to define the size of the HSBLC area.

8. Press **OK** to confirm the configuration and select **RET** to return to the HSBLC menu, or select **AGAIN** to re-define the HSBLC area.

- **LEVEL**

It is adjustable from 0 to 100. If the brightness is higher than the level you set, the HSBLC will take effect.

- **MODE**

ALL DAY refers to the HSBLC works all day; **Night** refers to the HSBLC only works in night.

- **BLACK MASK**

ON and **OFF** are selectable. Only when the **Black Mask** is set as ON, the HSBLC takes effect. If you the set black mask as OFF, the HSBLC function is disabled.

- **DEFAULT**

Selecting **DEFAULT** will restore all the HSBLC settings to the default value.

WDR

The wide dynamic range (WDR) function helps the camera provide clear images even under back light circumstances. When there are both very bright and very dark areas simultaneously in the field of view, WDR balances the brightness level of the whole image and provide clear images with details.

You can set the Gain level as low, middle, and high.

You can set the WDR Bright and offset value from 0 to 60.

3.3.6 White Balance (WB)

White balance is the white rendition function of the camera to adjust the color temperature according to the environment. It can remove the unrealistic color casts in the image.

MANUAL, **ATW (Auto-tracking White Balance)**, **AWC→SET** are selectable.

- **MANUAL**

Manual mode allows you to adjust the white balance by customizing the Blue and Red value, which range from 1 to 100.

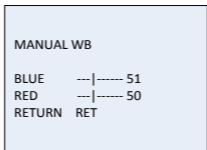

Figure 3-7 Manual White Balance

- **ATW**

ATW mode refers to the white balance is continuously being adjusted in real-time according to the color temperature of the scene illumination.

- **AWC→SET**

Similar with ATW, the white balance is continuously being adjusted in real-time according the scene if AWC→SET is selected, however, if the scene changed, you have to go to AWC→SET to get another proper white balance for the new scene.



The white balance is not adjustable if B/W mode is selected.

3.3.7 Day & Night

Color, B/W, EXT and **AUTO** are selectable for DAY and NIGHT switches.

- **COLOR**

The image is colored in day mode all the time.

- **B/W**

The image is black and white all the time, and the IR LED turns on in the low-light conditions.

- **EXT**

The image switches from color to B/W or from B/W to color automatically according to the light condition.

- **AUTO**

The image switches from color to B/W or from B/W to color automatically by comparing the configured threshold value with actual light condition.

Delay: You can set the latency duration before camera implementing the switch operation after the threshold intensity being reached.

This function can effectively prevent meaningless switches caused by sudden illumination change and lens blocking.

D->N (AGC): The threshold value is configurable from 0 to 100 for determining whether to switch the image from color to B/W in current light condition.

N->D (AGC): The threshold value is configurable from 0 to 100 for determining whether to switch the image from B/W to color in current light condition.

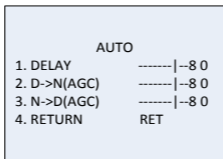

Figure 3-8 Auto

3.3.8 NR

NR (Noise Reduction) is used to reduce the noise in the video stream.

Move the cursor to **NR**, and press **OK** to enter the **NR** submenu.

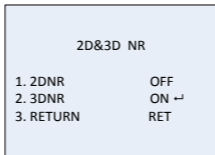

Figure 3-9 NR

- **2D NR**

2D NR reduces the noise in a single frame to get a gentle image. You can set it **ON** or **OFF** by setting the joystick to left/right.

• 3D NR

Compared to traditional general 2D NR technology, 3D NR processes the noise reduction between two frames instead of in one frame. It can decrease the noise effect, especially when capturing moving images in low light conditions and delivering more accurate and sharp image quality.

3D NR	
1. SMART NR	ON↵
2. LEVEL	----- --8 0
3. START. AGC	- -----10
4. END. AGC	- -----10
5. RETURN	RET

Figure 3-10 3D NR

Smart NR usually takes effect in cooperation with 3D NR. You can set it to **ON** to improve the image fluency. And set it to **OFF** to disable the SMART NR. The 3D smart NR sensitivity ranges from 0 to 100.

3D SMART NR	
1. SENSITIVITY	----- -- 80
2. RETURN	RET

Figure 3-11 Smart NR

The 3D NR level ranges from 0 to 100.

You can set a threshold to enable AGC from Start. AGC, and set a threshold to disable AGC from End.AGC.

3.3.9 SPECIAL

In the SPECIAL sub-menu, you can set the camera name, the digital effect of the image, the motion detection, privacy task, language, dead pixel correction, and check the version of the camera.

SPECIAL	
1. CAM TITLE	ON ↵
2. D-EFFECT	↵
3. MOTION	OFF
4. PRIVACY	OFF
5. DEFECT	↵
6. RS485	↵
7. RETURN	RET

Figure 3-12 Special

Camera Title

You can name your camera by configuring the CAM TITLE. Move the cursor to **CAM TITLE**, set it to **ON**, and press **OK** to enter the edit interface. Up to 15 characters can be selected.

ON: Display the camera title.

OFF: Do not display the camera title.

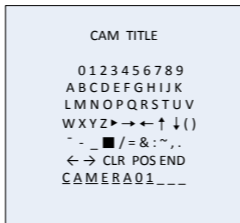

Figure 3-13 CAM Title

Steps:

1. Move the cursor to ← or →, and press **OK** to decide the character position on the dotted line.
2. Move the cursor to select the needed characters, numbers, and symbols.
3. Press **OK** to confirm. The selected character will be displayed on the dotted line below.
4. Move the cursor to **POS** to edit the camera title position on the screen.
 - 1). Move the cursor to POS.
 - 2). Press **OK** to enter the CAM TITLE position setting interface.
 - 3). Move the joystick up/down/left/right to change the position of camera title.
 - 4). Press **OK** to exit the CAM TITLE position setting interface, and return to the CAM TITLE menu.

5. (Optional) Move the cursor to **CLR** to clear all the selected characters.
6. Move the cursor to **END** and press **OK** to save the settings and return to the previous menu.

D-effect

D-EFFECT	
1. FREEZE	OFF
2. MIRROR	OFF
3. D-ZOOM	OFF
4. SMART D-ZOOM	OFF
5. NEG. IMAGE	OFF
6. RETURN	RET

Figure 3-14 D-effect

• FREEZE

You can set the freeze function as **ON** or **OFF**. When you set it as on, the image is frozen as still. The live view will stay on the moment you set the freeze ON.



The mirror function will be disabled if the FREEZE is ON.

• MIRROR

OFF, **MIRROR**, **V-FLIP**, and **ROTATE** are selectable for mirror.

OFF: The mirror function is disabled.

MIRROR: The image flips 180 degree horizontally.

V-FLIP: The image flips 180 degree vertically.

ROTATE: The image flips 180 degrees both horizontally and vertically.

• D-ZOOM

You can set the D-ZOOM as **ON** to zoom in the image. When digital zoom is processed, the image will be enlarged without gaining the actual pixel.

D-ZOOM	
1. D-ZOOM	x 2.0
2. PAN & TILT	↔
3. DEFAULT	↔
4. RETURN	RET

Figure 3-15 D-Zoom

The minimum magnification is x2, and the maximum magnification is x62.

You can define the zoom area by configuring the position from PAN & TILT, and restore the D-Zoom settings to the default.

• SMART D-ZOOM

The smart D-Zoom enlarges the motion object detected in the pre-defined area. The D-Zoom area, the sensitivity, and the time are configurable from the smart D-Zoom edit interface.

SMART D-ZOOM	
1. SELECT	AREA1
2. DISPLAY	ON↵
3. SENSITIVITY	--- ----31
4. D-ZOOM	x 2.0
5.TIME	-- -----3
6.DEFAULT	↵
7.RETURN	RET

Figure 3-16 Smart D-Zoom



D-Zoom and Smart D-Zoom cannot take effect simultaneously.

2 areas are selectable. Move the joystick up/down to select the area. Set the display ON/OFF to display/not display the smart D-Zoom area. And if the display is set to ON, press OK to enter the position edit interface and define the smart D-Zoom area.

The sensitivity ranges from 0 to 60. The higher the sensitivity, the easier the smart D-ZOOM is triggered.

The minimum magnification is x 2.0, and the maximum magnification is x62.0.

The time refers to the duration of the magnification, and you can set it from 0 to 15.

Move the cursor to **DEFAULT** and press **OK** to restore the smart D-Zoom settings to the default.

• NEG.IMAGE

You can set the NEG IMAGE as **ON** or **OFF**, and if you set it as on, the bright area and the dark area of the image are reversed.

Motion

In the user-defined motion detection surveillance area, the moving object can be detected and the alarm will be triggered.

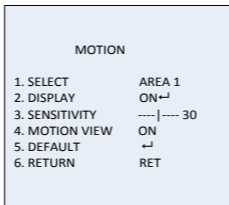

Figure 3-17 Motion Detection

Set a Motion Detection Area:

Steps:

1. Move the cursor to **SELECT** and select a motion area. Four areas are selectable.
2. Move the cursor to **DISPLAY**, set it **ON** and press **OK** to enter the motion detection edit interface.
3. Move the joystick up/down/left/right to define the position of the selected motion area.

4. Press **OK** to enter the area size configuration interface after the position is defined.
5. Move the joystick up/down/left/right to define the size of the selected area.
6. Press **OK** to confirm the size configuration and select **RET** to return to the motion menu, and select **AGAIN** to try again.
7. (Optional) Move the cursor to **DEFAULT** and press **OK** to restore the motion settings to the default.

- **SENSITIVITY**

It refers to the sensitivity of the motion detection, which ranges from 0 to 60. And the higher sensitivity causes the better response of the detection.

- **MOTION VIEW**

Motion view enables a better visual judgment when the motion is detected. Set the motion view ON, once motion occurred; you can see the transparent red mosaic flickering to show the exact location where the motion occurs. Or you can set it OFF to disable the motion view.

Privacy

The privacy mask allows you to cover certain areas which you don't want to be viewed or recorded. Up to 8 privacy areas are configurable.

PRIVACY	
1. SELECT	AREA 1
2. DISPLAY	MOSAIC ↵
3. COLOR	10
4. TRANS.	1
5. DEFAULT	↵
6. RETURN	RET

Figure 3-18 Privacy Mask

Set a Privacy Mask:

Steps:

1. Move the cursor to **SELECT** and select a privacy mask area. Eight areas are selectable.
2. Move the cursor to **DISPLAY**, and press **OK** to enter the privacy mask edit interface.

INV., mosaic, color and off are selectable for display.

INV.: The privacy mask area converts the bright area and the dark area in the image.

Mosaic: The privacy mask area displayed with the flickering mosaic.

Color: The privacy mask area is displayed with selectable colors. 16 colors are selectable.



The Color and TRANS [0-3] only works when the display is set to color.

3. Move the joystick up/down/left/right to define the position of the selected privacy mask area.
4. Press **OK** to enter the area size configuration interface after the position is defined. Define the size by configuring the top left, top right, bottom left, and bottom right of the selected area.
5. Press **OK** to confirm the configuration and select **RET** to return to the privacy mask menu, or select **AGAIN** to try again.
6. (Optional) Move the cursor to **DEFAULT** and press **OK** to restore the privacy mask settings to the default.

Defect

Defective pixels are pixels in a CCD or CMOS image sensor in digital cameras, in which the defective pixels fail to sense light levels correctly. This series of camera supports defective pixel correction. Move the cursor to **DEFECT** and press **OK** to enter the defective pixel correction interface.

DEFECT	
1. LIVE DPC	AUTO
2. STATIC DPC	ON↵
3. RETURN	RET

Figure 3-19 Defective Pixel Correction

- **LIVE DPC**

Live DPC detects and corrects the dynamic or the real-time defective pixels occur during the using. ON, OFF or AUTO is selectable. The correction level [0-255] is configurable if the live DPC is set to ON; set it OFF to disable the live defective pixel correction; and set it AUTO to detect and repair the defective pixels automatically.

- **STATIC DPC**

Static DPC detects and corrects the static or the fixed defective pixels occur during the using. ON and OFF are selectable.

STATIC DPC	
1.START	↵
2.LEVEL	← -----15
3.SENS-UP	x 20
4.AGC	-- -----2
5.RETURN	RET

Figure 3-20 Static DPC

Steps:

1. Set the static DPC as ON, and press OK to enter the static DPC edit interface.
2. Move the cursor to START, and press OK to start correcting the defective pixels.
3. Press **OK** when you see the message of **CLOSE THE IRIS THEN PRESS ENTER KEY** showing up on the screen.

The level of the STATIC DPC ranges from 0 to 60.

Some of the defective pixels may appear undistinguished for the system to detect. You can adjust the SENS-UP to X2, X4, X6, X8, X10, X15, X20, X25 or X30 to brighten the defective pixel for the system to find it. You can set the AGC level from 0 to 8.

RS485

You can set the parameters of RS485 in this menu, including camera ID, ID display status and baud rate (2400/4800/9600/19200/38400).

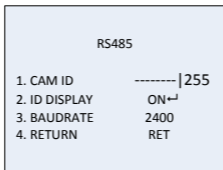

Figure 3-21 RS485

3.3.10 ADJUST

In the Adjust sub-menu, you can configure the settings, including the sharpness, the image quality on monitor, the OSD settings, the lens shadow compensation, and the video output standard, etc. Move the cursor to ADJUST and press OK to enter the adjust configuration interface.

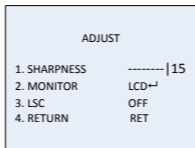

Figure 3-22 Adjust

Sharpness

Sharpness determines the amount of detail an imaging system can reproduce. And you can adjust the sharpness from 0 to 15. The higher the value is, the clearer and sharper the image appears.

Monitor

Monitor CRT, and Monitor LCD are selectable.

The cathode ray tube (CRT) is a fluorescent screen used to view images. You can user-define the black level [-30~+30], the blue gain [-50~50], and the red gain [-50~50].

CRT	
1. BLACK LEVEL	---- ----+0
2. BLUE GAIN	---- ----50
3. RED GAIN	---- ----60
4. RETURN	RET

Figure 3-23 Monitor CRT

If liquid-crystal display (LCD) is selected. You can user-define the gamma, blue gain [0~100], and red gain [0~100].

Gamma is the name of a nonlinear operation used to code and decode luminance or tristimulus values in video or still image system.

USER +Y, USER, AUTO, 1.00, 0.95, 0.90, 0.85, 0.80, 0.75, 0.70, 0.65, 0.60, 0.55, 0.50, and 0.45 are selectable.

LCD	
1. GAMMA	AUTO
2. BLUE GAIN	---- ----50
3. RED GAIN	---- ----50
4. RETURN	RET

Figure 3-24 Monitor LCD

LSC

Lens Shading Correction (LSC) corrects the phenomenon where the image gets darkened or blurred on the periphery.

Set it ON to enable the LSC.

Set it OFF to disable the LSC.

3.3.11 RESET

Reset all the settings to the default.

3.3.12 EXIT

Move the cursor to EXIT and press **OK** to exit the menu.

First Choice for Security Professionals