



EMC TEST REPORT

Authorized under **Declaration of Conformity**

According to

EN 55022:2010

EN 61000-6-3: 2007

EN 61000-3-2: 2006+A2: 2009

EN 61000-3-3 : 2008

EN 55024 : 2010

EN 50130-4: 2011

IEC 61000-4-2 : 2008

IEC 61000-4-3 : 2010

IEC 61000-4-4 : 2012

IEC 61000-4-5 : 2005

IEC 61000-4-6 : 2008

IEC 61000-4-8 : 2009

IEC 61000-4-11 : 2004

Applicant : Zhejiang Dahua Vision Technology Co., Ltd.

Address : The 1st floor, building F, No.1199 Bin'an road,
Changhe Street, Binjiang District, Hangzhou, P.R.
China.

Equipment : Outdoor Station

Model No. : DH-VTO

- The test result refers exclusively to the test presented test model / sample.
- Without written approval of **Cerpass Technology(Suzhou) Corp.** the test report shall not be reproduced except in full.
- This test report is only applicable to European Community.
- The test report must not be used by the clients to claim product certification approval by **NVLAP** or any agency of the Government.



Contents

CERTIFICATE OF COMPLIANCE	5
1. Summary of Test Procedure and Test Results	6
2. Immunity Testing Performance Criteria Definition	7
3. Test Configuration of Equipment under Test	8
3.1. Manufacturer	8
3.2. Feature of Equipment under Test.....	8
3.3. Test Software and Test Mode.....	8
3.4. Description of Support Unit	8
3.5. General Information of Test.....	9
3.6. Measurement Uncertainty	9
4. Test of Conducted Emission.....	10
4.1. Test Limit	10
4.2. Test Procedures	11
4.3. Typical Test Setup	11
4.4. Measurement equipment	12
4.5. Test Data and Result.....	13
4.6. Test Photographs	16
5. Test of Radiated Emission	18
5.1. Test Limit	18
5.2. Test Procedures	19
5.3. Typical test Setup.....	20
5.4. Measurement equipment	21
5.5. Test Result and Data (30MHz ~ 1000MHz)	22
5.6. Test Result and Data (1000MHz ~ 6000MHz)	24
5.7. Test Photographs (30MHz ~ 1000MHz).....	26
5.8. Test Photographs (1000MHz ~ 6000MHz).....	27
6. Harmonics Test	28
6.1. Limits of Harmonics Current Measurement	28
6.2. Measurement equipment	28
6.3. Test Result and Data	29
6.1. Test Photographs	31
7. Voltage Fluctuations Test	32
7.1. Test Procedure	32
7.2. Measurement equipment	32
7.3. Test Result and Data	33
7.4. Test Photographs	35
8. Electrostatic Discharge Immunity Test	36
8.1. Test Procedure	36
8.2. Test Setup for Tests Performed in Laboratory.....	37
8.3. Test Severity Levels	38



8.4. Measurement equipment	38
8.5. Test Result and Data	39
8.6. Test Photographs	41
9. Radio Frequency electromagnetic field immunity test	42
9.1. Test Procedure	42
9.2. Test Severity Levels	43
9.3. Measurement equipment	43
9.4. Test Result and Data	44
9.5. Test Photographs	46
10. Electrical Fast Transient/ Burst Immunity Test	47
10.1. Test Procedure	47
10.2. Test Severity Levels	48
10.3. Measurement equipment	48
10.4. Test Result and Data	49
10.5. Test Photographs	52
11. Surge Immunity Test	53
11.1. Test Procedure	53
11.2. Test Severity Level	54
11.3. Measurement equipment	54
11.4. Test Result and Data	55
11.5. Test Photographs	59
12. Conduction Disturbances induced by Radio-Frequency Fields	60
12.1. Test Procedure	60
12.2. Test Severity Levels	61
12.3. Measurement equipment	61
12.4. Test Result and Data	62
12.5. Test Photographs	64
13. Power Frequency Magnetic Field Immunity Tests	65
13.1. Test Setup	65
13.1. Test Severity Levels	65
13.1. Measurement equipment	65
13.1. Test Result and Data	66
13.2. Test Photographs	67
14. Voltage Dips and Voltage Interruptions Immunity Test Setup	68
14.1. Test Conditions	68
14.2. Measurement equipment	68
14.3. Test Result and Data	69
14.4. Test Photographs	72
15. EUT Photographs	73



CERTIFICATE OF COMPLIANCE

According to

EN 55022:2010	EN 55024 : 2010
EN 61000-6-3: 2007	EN 50130-4: 2011
EN 61000-3-2: 2006+A2: 2009	IEC 61000-4-2 : 2008
EN 61000-3-3 : 2008	IEC 61000-4-3 : 2010
	IEC 61000-4-4 : 2012
	IEC 61000-4-5 : 2005
	IEC 61000-4-6 : 2008
	IEC 61000-4-8 : 2009
	IEC 61000-4-11 : 2004

Applicant : Zhejiang Dahua Vision Technology Co., Ltd.
Address : The 1st floor, building F, No.1199 Bin'an road,
Changhe Street, Binjiang District, Hangzhou, P.R.
China.
Equipment : Outdoor Station
Model No. : DH-VTO

I HEREBY CERTIFY THAT :

The measurements shown in this test report were made in accordance with the procedures given in **EUROPEAN COUNCIL DIRECTIVE 2004/108/EC.**

The test was carried out on Apr 03, 2013 at **CerpPASS Technology(Suzhou) Corp.**

Signature

Miro Chueh/ Technical director



1. Summary of Test Procedure and Test Results

EMISSION(EN 55022:2010 / EN 61000-6-3: 2007)		
Test Item	Normative References	Test Result
Conducted Emission	EN 55022 : 2010 EN 61000-6-3: 2007	PASS
Radiated Emission	EN 55022 : 2010 EN 61000-6-3: 2007	PASS
Harmonics	EN 61000-3-2: 2006+A2: 2009	PASS
Voltage Fluctuations	EN 61000-3-3: 2008	PASS

IMMUNITY (EN 55024 : 2010)		
Test Item	Test Spec	Test Result
Electrostatic Discharge Immunity Test (ESD)	± 4 kV (contact discharge, HCP/VPC) ± 8 kV (Air discharge)	PASS
Radio Frequency electromagnetic field immunity test (RS)	80-1000 MHz, 3V/m, 80%AM(1KHz)	PASS
Electrical Fast Transient/ Burst Immunity Test (EFT)	AC Port: ± 1 kV, Signal Port: ± 0.5 kV	PASS
Surge Immunity Test	AC Power Ports: Line to Line: ± 1 kV Line to earth: ± 2 kV Signal and telecommunication port: ± 1 kV	PASS
Conduction Disturbances induced by Radio-Frequency Fields	0.15-80MHz, 3V, 80%AM(1KHz)	PASS
Power Frequency Magnetic Field Immunity Test	50Hz, 1A/m	PASS
Voltage Dips and Voltage Interruptions Immunity Test	Voltage dips: >95% Reduction, 0.5 Durations (Cycle)	PASS
	30% Reduction, 25 Durations (Cycle)	PASS
	Voltage interruptions: >95% Reduction, 250 Durations (Cycle)	PASS



IMMUNITY (EN 50130-4: 2011)		
Test Item	Test Spec	Test Result
Electrostatic Discharge Immunity Test (ESD)	± 6 kV (contact discharge ,HCP/VPC) ± 8 kV (Air discharge)	PASS
Radio Frequency electromagnetic field immunity test (RS)	80-2700 MHz, 10V/m, 80%AM(1KHz)	PASS
Electrical Fast Transient/ Burst Immunity Test (EFT)	AC Port: ± 2.0 kV, Signal Port: ± 1.0 kV	PASS
Surge Immunity Test	AC Power Ports: line to line: ± 0.5 , ± 1 kV line to earth: ± 0.5 , ± 1 , ± 2 kV Signal Port: ± 0.5 , ± 1 kV	PASS
Conduction Disturbances induced by Radio-Frequency Fields	0.15-100MHz, 10V, 80%AM(1KHz)	PASS
Voltage Dips and Voltage Interruptions Immunity Test	Voltage Interruptions: 100% Reduction, 250 Cycle	PASS
	Voltage Dips: 60% Reduction, 10 Cycle 30% Reduction, 25 Cycle 20% Reduction, 250 Cycle	PASS

2. Immunity Testing Performance Criteria Definition

- A. Normal performance within limits specified by the manufacture, requestor or purchaser;
- B. Temporary loss of function or degradation of performance which ceases after the disturbance ceases, and from which the equipment under test recovers its normal performance, without operator intervention;
- C. Temporary loss of function or degradation of performance, the correction of which requires operation intervention;
- D. Loss of function or degradation of performance which is not recoverable, owing to damage to hardware or software, or loss of data.



3. Test Configuration of Equipment under Test

3.1. Manufacturer

Zhejiang Dahua Vision Technology Co., Ltd.

The 1st floor, building F, No.1199 Bin'an road, Changhe Street, Binjiang District, Hangzhou, P.R. China.

3.2. Feature of Equipment under Test

Outdoor Station	Model No.:	DH-VTO
Adapter	Model No.:	KPA-060F
	Input:	100-240V~ 50-60Hz 1.7A
	Output:	12V  5.0A
DC Cable	Non-shielded, 1.5m, with one ferrite core bonded	

3.3. Test Software and Test Mode

Test Software

- a During testing, the interface cables and equipment positions were varied according to Europe Standard.
- b Turn on the power of all equipment.
- c The complete test system included the accessory and EUT for EMC test.

The pre-test modes

Test Mode 1: Normal Operation

Select the worst case of the pre-test modes as the final test mode

Test Mode 1: Normal Operation

3.4. Description of Support Unit

No.	Device	Manufacturer	Model No.	Description
1	Indoor monitor	DaHua	DH-VTH	N/A

Item	Cable	Quantity	Description
A	LAN Cable	1	Non-Shielded, >3.0M
B	LAN Cable	1	Non-Shielded, 3.0M



3.5. General Information of Test

Test Site:	Cerpass Technology (Suzhou) Co.,Ltd
Test Site Location :	No.66,Tangzhuang Road, Suzhou Industrial Park, Jiangsu 215006, China
NVLAP LAB Code :	200814-0
FCC Registration Number :	916572, 331395
IC Registration Number :	7290A-1, 7290A-2
VCCI Registration Number :	T-1945 for Telecommunication Test C-2919 for Conducted emission test R-2670 for Radiated emission test below 1GHz G-227 for Radiated emission test above 1GHz
Frequency Range Investigated :	Conducted Emission Test: from 150kHz to 30 MHz Radiated Emission Test: from 30 MHz to 1,000 MHz Radiated Emission Test: from 1GHz to 6GHz
Test Distance :	The test distance of radiated emission below 1GHz from antenna to EUT is 10 M. The test distance of radiated emission above 1GHz from antenna to EUT is 3 M.

LABORATORY ACCREDITATION



3.6. Measurement Uncertainty

Conducted Emission		
The measurement uncertainty is evaluated as ± 2.71 dB.		
Radiated Emission		
(30MHz -1000MHz)	Horizontal	The measurement uncertainty is evaluated as ± 3.59 dB.
	Vertical	The measurement uncertainty is evaluated as ± 3.89 dB
(1G-6GHz)	Horizontal	The measurement uncertainty is evaluated as ± 2.31 dB.
	Vertical	The measurement uncertainty is evaluated as ± 2.15 dB.



4. Test of Conducted Emission

4.1. Test Limit

Conducted Emissions were measured from 150 kHz to 30 MHz with a bandwidth of 9 kHz and return leads of the EUT according to the methods defined in European Standard EN 61000-6-3. The EUT was placed on a nonmetallic stand in a shielded room 0.8 meters above the ground plane. The interface cables and equipment positioning were varied within limits of reasonable applications to determine the position producing maximum conducted emissions.

Table 1 Class B Line Conducted Emission Limits:

Frequency range (MHz)	Limits (dB μ V)	
	Quasi Peak	Average
0.15 to 0.50	66 to 56	56 to 46
0.50 to 5	56	46
5. to 30.	60	50

Note 1: The lower limits shall apply at the transition frequencies.
 Note 2: The limit decreases linearly with the logarithm of the frequency in the range 0.15 MHz to .50MHz.

Table 2 - Limits of conducted common mode (asymmetric mode) disturbance at telecommunication ports in the frequency range 0.15 MHz to 30 MHz for class B equipment.

Frequency range (MHz)	Voltage limits dB(μ V)		Current limits dB(μ A)	
	Quasi-peak	Average	Quasi-peak	Average
0.15 to 0.5	84 to 74	74 to 64	40 to 30	30 to 20
0.5 to 30	74	64	30	20

Note 1: The limits decrease linearly with the logarithm of the frequency in the range 0.15 to 0.5 MHz.
 Note 2: The current and voltage disturbance limits are derived for use with an impedance stabilization network (ISN) which presents a common mode (asymmetric mode) impedance of 150 Ω to the telecommunication under test (conversion factor is $20 \log_{10} 150/1 = 44\text{dB}$).



4.4. Measurement equipment

Instrument/Ancillary	Manufacturer	Model No.	Serial No.	Calibration Date	Valid Date.
Test Receiver	R&S	ESCI	100565	2012.11.05	2013.11.04
AMN	R&S	ESH2-Z5	100182	2012.11.05	2013.11.04
Two-Line V-Network	R&S	ENV216	100325	2013.03.10	2014.03.09
ISN	FCC	FCC-TLISN-T2-02	20379	2012.12.08	2013.12.07
ISN	FCC	FCC-TLISN-T4-02	20380	2012.12.08	2013.12.07
ISN	FCC	FCC-TLISN-T8-02	20381	2012.12.08	2013.12.07
ISN	TESEQ	ISN ST08	30175	2012.09.13	2013.09.12
Current Probe	R&S	EZ-17	100303	2013.03.10	2014.03.09
Passive Voltage Probe	R&S	ESH2-Z3	100026	2013.03.10	2014.03.09
Attenuator	R&S	ESH3-Z2	100529	2013.03.10	2014.03.09
Temperature/ Humidity Meter	Zhicheng	ZC1-11	CEP-TH-004	2013.03.10	2014.03.09



4.5. Test Data and Result

Test Mode :	Mode 1: Normal Operation		
AC Power :	AC 230V/50Hz	Phase :	LINE
Equipment :	Outdoor Station	Model No :	DH-VTO
Temperature :	22°C	Humidity :	50%
Pressure(mbar) :	1002	Date:	2013/04/03

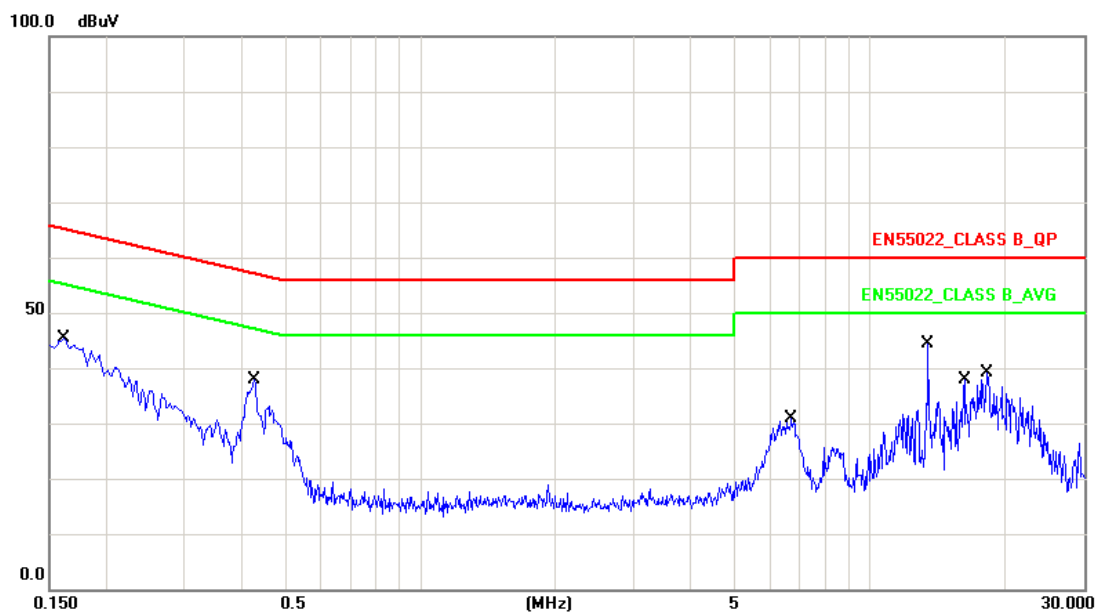

No.	Frequency (MHz)	Factor (dB)	Reading (dBuV)	Level (dBuV)	Limit (dBuV)	Margin (dB)	Detector
1	0.1620	9.87	31.98	41.85	65.36	-23.51	QP
2	0.1620	9.87	11.60	21.47	55.36	-33.89	AVG
3	0.4300	9.86	22.08	31.94	57.25	-25.31	QP
4	0.4300	9.86	11.36	21.22	47.25	-26.03	AVG
5	6.7100	9.73	13.98	23.71	60.00	-36.29	QP
6	6.7100	9.73	4.98	14.71	50.00	-35.29	AVG
7	13.5020	9.79	33.92	43.71	60.00	-16.29	QP
8	13.5020	9.79	34.25	44.04	50.00	-5.96	AVG
9	16.2300	9.75	26.83	36.58	60.00	-23.42	QP
10	16.2300	9.75	23.54	33.29	50.00	-16.71	AVG
11	18.2420	9.64	26.50	36.14	60.00	-23.86	QP
12	18.2420	9.64	22.91	32.55	50.00	-17.45	AVG

Note: Measurement Level = Reading Level + Correct Factor



Test Mode :	Mode 1: Normal Operation		
AC Power :	AC 230V/50Hz	Phase :	NEUTRAL
Equipment :	Outdoor Station	Model No :	DH-VTO
Temperature :	22 °C	Humidity :	50%
Pressure(mbar) :	1002	Date:	2013/04/03

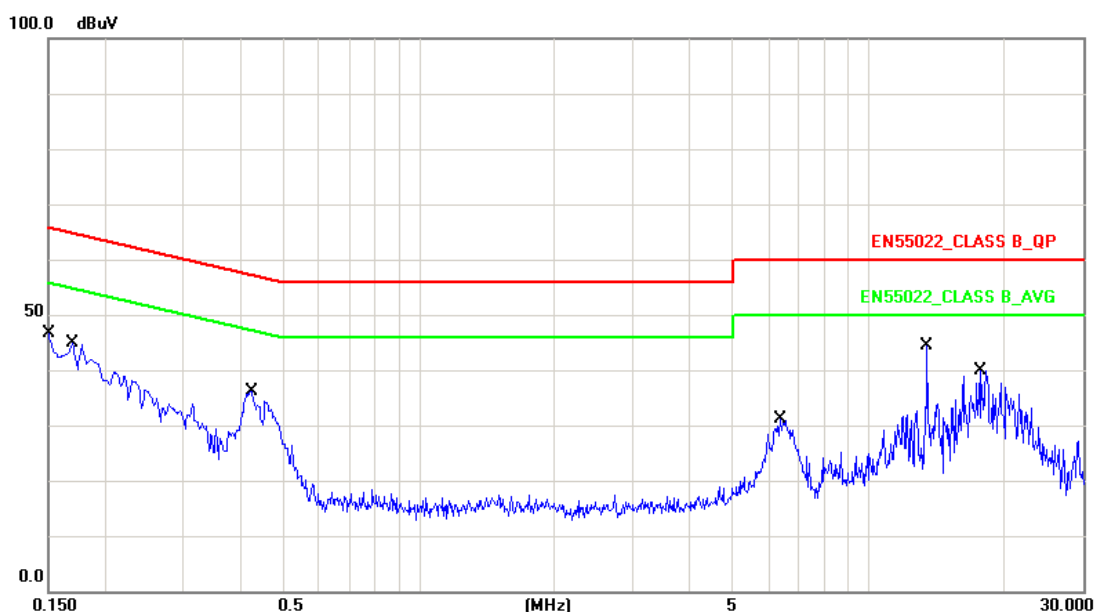

No.	Frequency (MHz)	Factor (dB)	Reading (dBuV)	Level (dBuV)	Limit (dBuV)	Margin (dB)	Detector
1	0.1500	9.50	32.77	42.27	65.99	-23.72	QP
2	0.1500	9.50	12.07	21.57	55.99	-34.42	AVG
3	0.1700	9.50	31.11	40.61	64.96	-24.35	QP
4	0.1700	9.50	11.26	20.76	54.96	-34.20	AVG
5	0.4260	9.50	24.55	34.05	57.33	-23.28	QP
6	0.4260	9.50	14.70	24.20	47.33	-23.13	AVG
7	6.3580	9.68	14.29	23.97	60.00	-36.03	QP
8	6.3580	9.68	4.24	13.92	50.00	-36.08	AVG
9	13.5020	9.90	33.72	43.62	60.00	-16.38	QP
10	13.5020	9.90	34.08	43.98	50.00	-6.02	AVG
11	17.6940	9.94	27.55	37.49	60.00	-22.51	QP
12	17.6940	9.94	23.98	33.92	50.00	-16.08	AVG

Note: Measurement Level = Reading Level + Correct Factor



Test Mode :	Mode 1: Normal Operation		
AC Power :	AC 230V/50Hz	Phase :	ISN
Equipment :	Outdoor Station	Model No :	DH-VTO
Temperature :	22°C	Humidity :	50%
Pressure(mbar) :	1002	Date:	2013/04/03

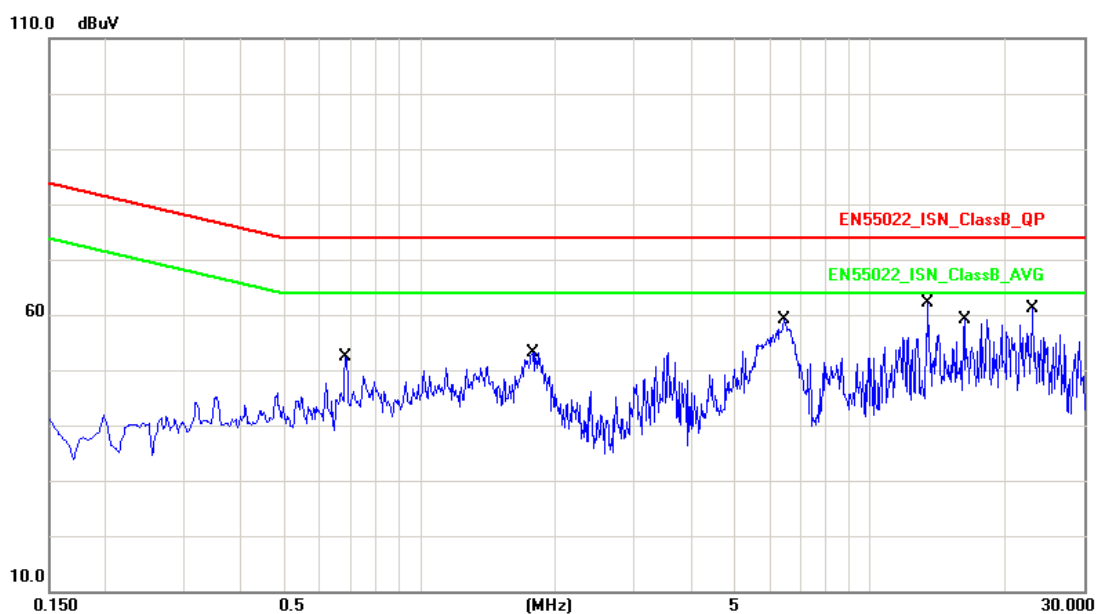

No.	Frequency (MHz)	Factor (dB)	Reading (dBuV)	Level (dBuV)	Limit (dBuV)	Margin (dB)	Detector
1	0.6860	9.90	40.08	49.98	74.00	-24.02	QP
2	0.6860	9.90	38.56	48.46	64.00	-15.54	AVG
3	1.7900	9.92	37.45	47.37	74.00	-26.63	QP
4	1.7900	9.92	28.13	38.05	64.00	-25.95	AVG
5	6.4820	10.01	39.86	49.87	74.00	-24.13	QP
6	6.4820	10.01	28.53	38.54	64.00	-25.46	AVG
7	13.5020	9.96	50.58	60.54	74.00	-13.46	QP
8	13.5020	9.96	50.92	60.88	64.00	-3.12	AVG
9	16.2300	9.98	48.13	58.11	74.00	-15.89	QP
10	16.2300	9.98	46.41	56.39	64.00	-7.61	AVG
11	23.1299	10.06	50.74	60.80	74.00	-13.20	QP
12	23.1299	10.06	49.11	59.17	64.00	-4.83	AVG

Note: Measurement Level = Reading Level + Correct Factor

Test engineer: Seben



4.6. Test Photographs

Main port

Front View



Rear View





LAN Port

Front View



Rear View





5. Test of Radiated Emission

5.1. Test Limit

The EUT shall meet the limits of below Table when measured at the measuring distance R in accordance with the methods described in European Standard EN 61000-6-3. If the reading on the measuring receiver shows fluctuations close to the limit, the reading shall be observed for at least 15 s at each measurement frequency; the highest reading shall be recorded, with the exception of any brief isolated high reading, which shall be ignored.

Table – Limits for radiated disturbance of class B ITE at a measuring distance of 10 m

Frequency range MHz	Quasi-peak limits dB(μ V/m)
30 to 230	30
230 to 1000	37
NOTE 1 The lower limit shall apply at the transition frequency. NOTE 2 Additional provisions may be required for cases where interference occurs.	

The EUT shall meet the limits of below Table when measured in accordance with the method described in European Standard EN 61000-6-3 and the conditional testing procedure described below.

Table – Limits for radiated disturbance of class B ITE at a measuring distance of 3 m

Frequency range GHz	Average limit dB(μ V/m)	Peak limits dB(μ V/m)
1 to 3	50	70
3 to 6	54	74
NOTE The lower limit applies at the transition frequency.		

• Conditional testing procedure:

The highest internal source of an EUT is defined as the highest frequency generated or used within the EUT or on which the EUT operates or tunes.

If the highest frequency of the internal sources of the EUT is less than 108 MHz, the measurement shall only be made up to 1 GHz.

If the highest frequency of the internal sources of the EUT is between 108 MHz and 500 MHz, the measurement shall only be made up to 2 GHz.

If the highest frequency of the internal sources of the EUT is between 500 MHz and 1 GHz, the measurement shall only be made up to 5 GHz.

If the highest frequency of the internal sources of the EUT is above 1 GHz, the measurement shall be made up to 5 times the highest frequency or 6 GHz, whichever is less.



5.2. Test Procedures

- a. The EUT was placed on a relatable table top 0.8 meter above ground.
- b. The EUT was set 10 meters from the interference receiving antenna which was mounted on the top of a variable height antenna tower.
- c. The table was rotated 360 degrees to determine the position of the highest radiation.
- d. The antenna is a half wave dipole and its height is varied between one meter and four meters above ground to find the maximum value of the field strength both horizontal polarization and vertical polarization of the antenna are set to make the measurement.
- e. For each suspected emission the EUT was arranged to its worst case and then tune the antenna tower (from 1 M to 4 M) and turn table (from 0 degree to 360 degrees) to find the maximum reading.
- f. Set the test-receiver system to Peak Detect Function and specified bandwidth with Maximum Hold Mode.



5.3. Typical test Setup

Below 1GHz Test Setup

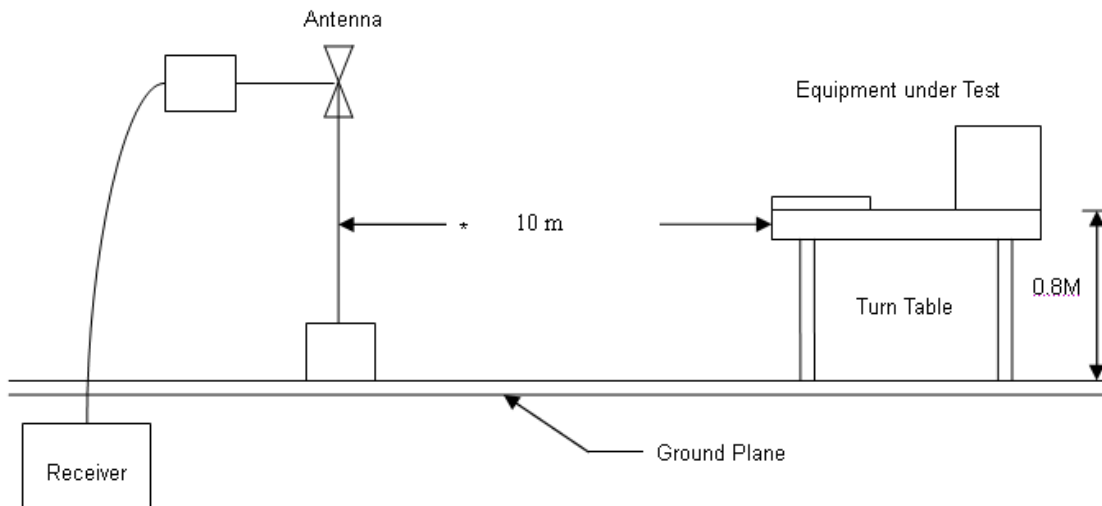

Above 1GHz Test Setup

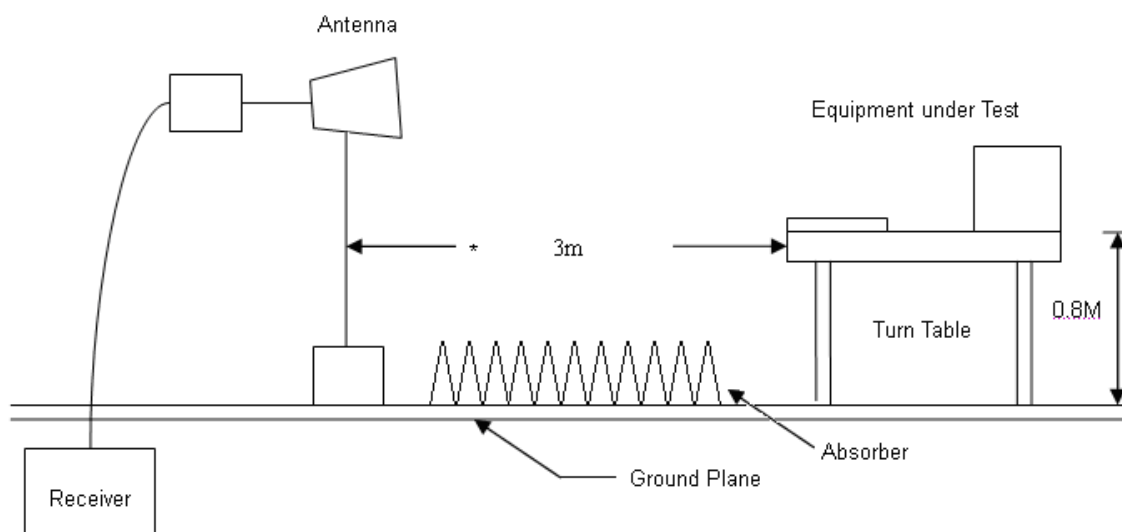



5.4. Measurement equipment

Instrument/Ancillary	Manufacturer	Model No.	Serial No.	Calibration Date	Valid Date.
EMI Test Receiver	R&S	ESCI	101183	2013.03.10	2014.03.09
Preamplifier	Agilent	87405B	My39500554	2013.03.10	2014.03.09
Preamplifier	Agilent	8449B	3008A02342	2013.03.10	2014.03.09
Ultra Broadband Antenna	R&S	HL562	100363	2012.05.03	2013.05.02
Broad-Band Horn Antenna	Schwarzbeck	BBHA9120D	9120D-618	2012.05.03	2013.05.02
Spectrum Analyzer	R&S	FSP40	100324	2013.03.10	2014.03.09
Temperature/ Humidity Meter	Zhicheng	ZC1-11	CEP-TH-001	2013.03.10	2014.03.09



5.5. Test Result and Data (30MHz ~ 1000MHz)

Test Mode :	Mode 1: Normal Operation		
AC Power :	AC 230V/50Hz	Ant. Polarization:	Horizontal
Equipment :	Outdoor Station	Model No :	DH-VTO
Temp :	23°C	Humidity :	52%
Pressure(mbar) :	1002	Date :	2013/04/03

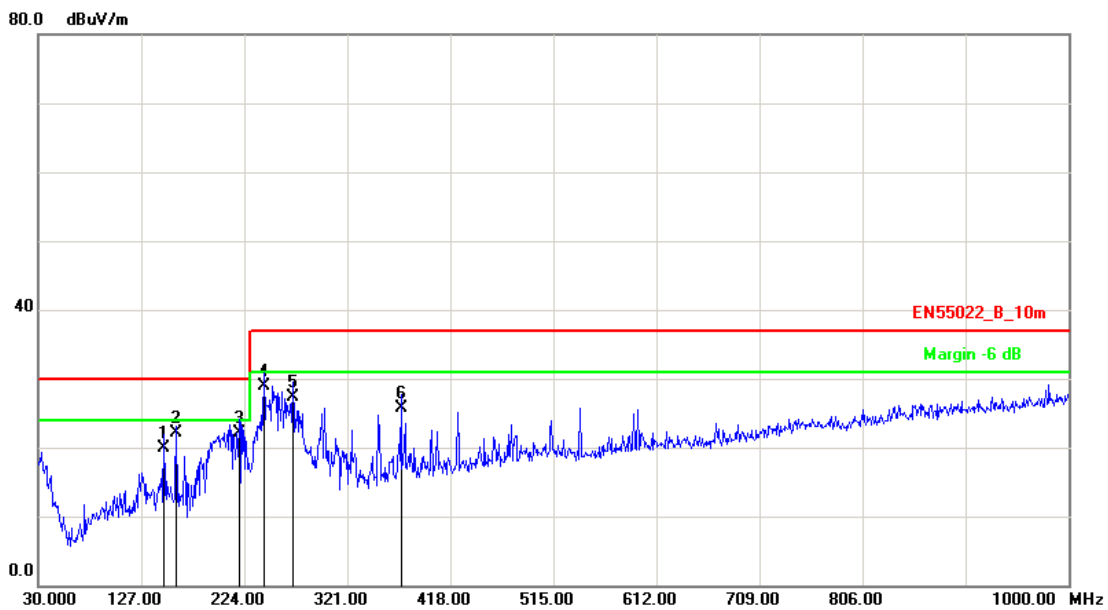

No.	Frequency (MHz)	Factor (dB/m)	Reading (dBuV)	Level (dBuV/m)	Limit (dBuV/m)	Margin (dB)	Det.	Height (cm)	Azimuth (deg)
1	148.3400	-15.21	35.16	19.95	30.00	-10.05	QP	400	80
2	159.9800	-15.30	37.44	22.14	30.00	-7.86	QP	400	56
3	219.1500	-14.52	36.57	22.05	30.00	-7.95	QP	400	105
4	242.4300	-13.24	42.17	28.93	37.00	-8.07	QP	400	111
5	269.5899	-12.17	39.52	27.35	37.00	-9.65	QP	400	83
6	371.4400	-9.25	34.94	25.69	37.00	-11.31	QP	218	0

Note: Measurement Level = Reading Level + Correct Factor



Test Mode :	Mode 1: Normal Operation		
AC Power :	AC 230V/50Hz	Ant. Polarization:	Vertical
Equipment :	Outdoor Station	Model No :	DH-VTO
Temp :	23°C	Humidity :	52%
Pressure(mbar) :	1002	Date :	2013/04/03

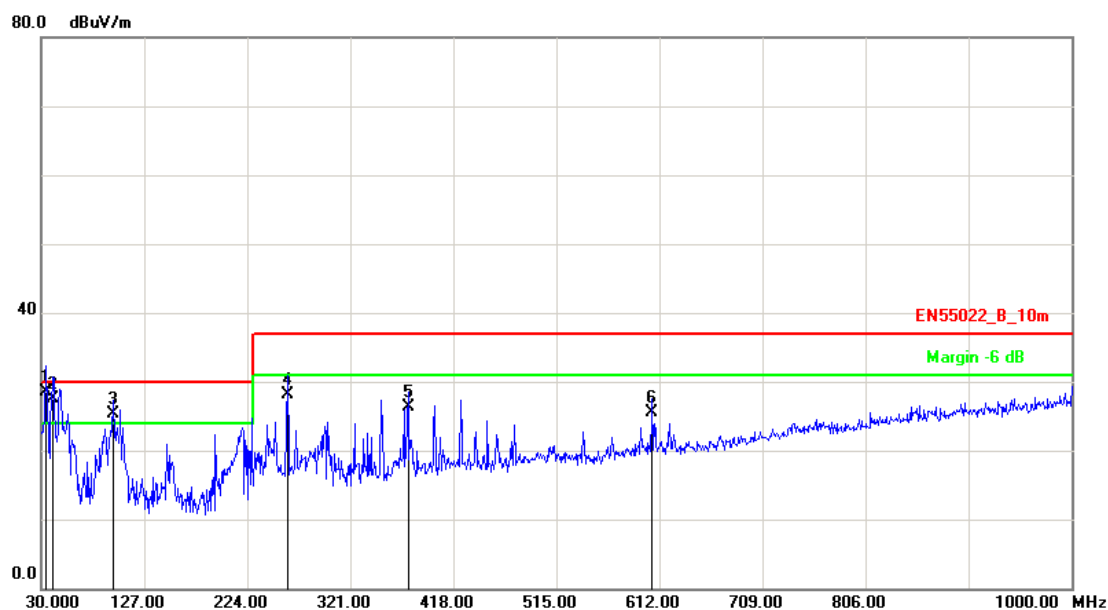

No.	Frequency (MHz)	Factor (dB/m)	Reading (dBuV)	Level (dBuV/m)	Limit (dBuV/m)	Margin (dB)	Det.	Height (cm)	Azimuth (deg)
1	34.6450	-7.78	36.19	28.41	30.00	-1.59	QP	100	354
2	41.6200	-11.24	38.67	27.43	30.00	-2.57	QP	100	356
3	97.9000	-14.73	39.98	25.25	30.00	-4.75	QP	100	301
4	261.8299	-12.43	40.59	28.16	37.00	-8.84	QP	394	0
5	375.3200	-9.16	35.54	26.38	37.00	-10.62	QP	100	1
6	605.2100	-3.66	29.07	25.41	37.00	-11.59	QP	100	233

Note: Measurement Level = Reading Level + Correct Factor



5.6. Test Result and Data (1000MHz ~ 6000MHz)

Test Mode :	Mode 1: Normal Operation		
AC Power :	AC 230V/50Hz	Ant. Polarization:	Horizontal
Equipment :	Outdoor Station	Model No :	DH-VTO
Temp :	23°C	Humidity :	52%
Pressure(mbar) :	1002	Date :	2013/04/03

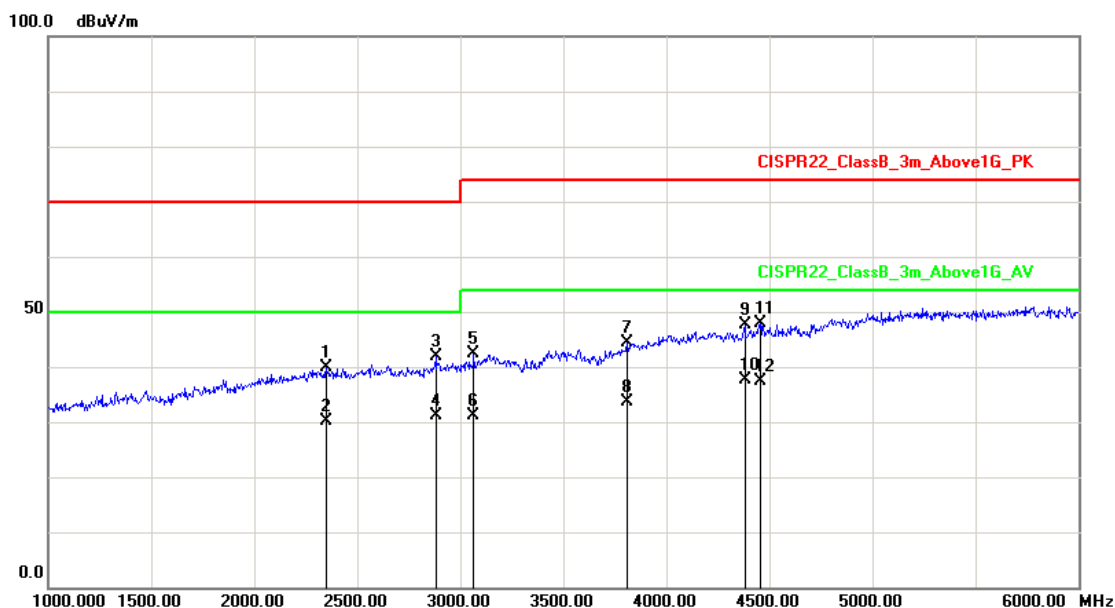

No.	Frequency (MHz)	Factor (dB/m)	Reading (dBuV)	Level (dBuV/m)	Limit (dBuV/m)	Margin (dB)	Det.	Height (cm)	Azimuth (deg)
1	2350.000	-4.44	44.20	39.76	70.00	-30.24	peak	100	33
2	2350.000	-4.44	34.55	30.11	50.00	-19.89	AVG	100	33
3	2880.000	-3.19	45.11	41.92	70.00	-28.08	peak	100	33
4	2880.000	-3.19	34.24	31.05	50.00	-18.95	AVG	100	33
5	3065.000	-3.07	45.37	42.30	74.00	-31.70	peak	100	18
6	3065.000	-3.07	34.31	31.24	54.00	-22.76	AVG	100	18
7	3810.000	-0.17	44.64	44.47	74.00	-29.53	peak	100	319
8	3810.000	-0.17	33.82	33.65	54.00	-20.35	AVG	100	319
9	4380.000	3.81	43.80	47.61	74.00	-26.39	peak	100	345
10	4380.000	3.81	33.78	37.59	54.00	-16.41	AVG	100	345
11	4455.000	4.21	43.68	47.89	74.00	-26.11	peak	100	12
12	4455.000	4.21	33.29	37.50	54.00	-16.50	AVG	100	12

Note: Measurement Level = Reading Level + Correct Factor



Test Mode :	Mode 1: Normal Operation		
AC Power :	AC 230V/50Hz	Ant. Polarization:	Vertical
Equipment :	Outdoor Station	Model No :	DH-VTO
Temp :	23°C	Humidity :	52%
Pressure(mbar) :	1002	Date :	2013/04/03

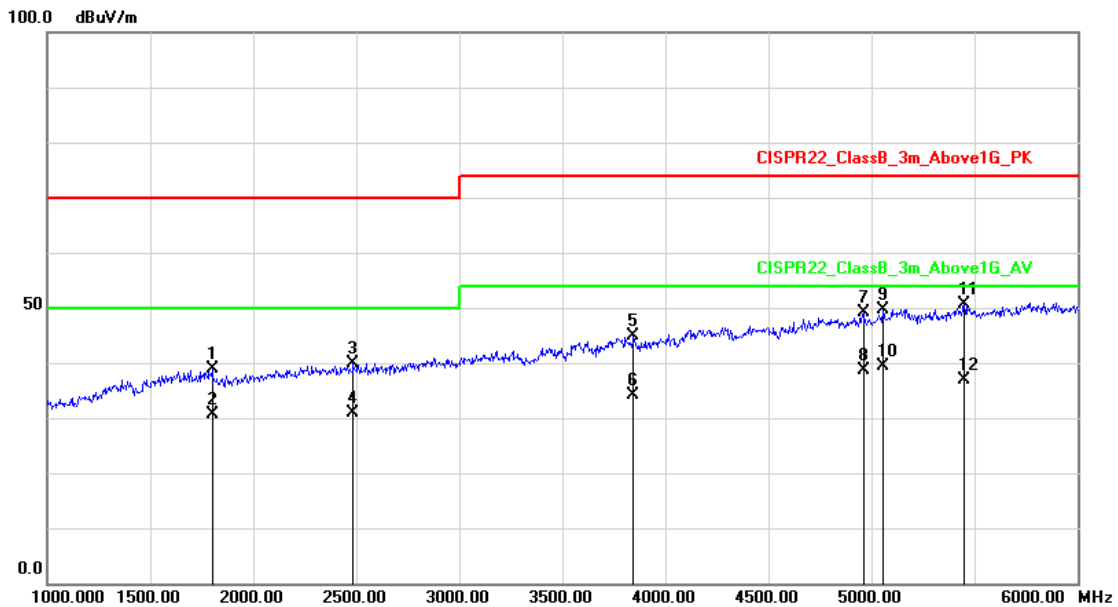

No.	Frequency (MHz)	Factor (dB/m)	Reading (dBuV)	Level (dBuV/m)	Limit (dBuV/m)	Margin (dB)	Det.	Height (cm)	Azimuth (deg)
1	1800.000	-11.03	49.80	38.77	70.00	-31.23	peak	100	188
2	1800.000	-11.03	41.64	30.61	50.00	-19.39	AVG	100	188
3	2485.000	-3.78	43.68	39.90	70.00	-30.10	peak	100	91
4	2485.000	-3.78	34.65	30.87	50.00	-19.13	AVG	100	91
5	3845.000	0.20	44.66	44.86	74.00	-29.14	peak	100	13
6	3845.000	0.20	33.98	34.18	54.00	-19.82	AVG	100	13
7	4960.000	7.46	41.60	49.06	74.00	-24.94	peak	100	337
8	4960.000	7.46	31.20	38.66	54.00	-15.34	AVG	100	337
9	5055.000	7.75	41.76	49.51	74.00	-24.49	peak	100	0
10	5055.000	7.75	31.59	39.34	54.00	-14.66	AVG	100	0
11	5450.000	7.93	42.73	50.66	74.00	-23.34	peak	100	102
12	5450.000	7.93	29.01	36.94	54.00	-17.06	AVG	100	102

Note: Measurement Level = Reading Level + Correct Factor

Test engineer: Seben



5.7. Test Photographs (30MHz ~ 1000MHz)

Front View

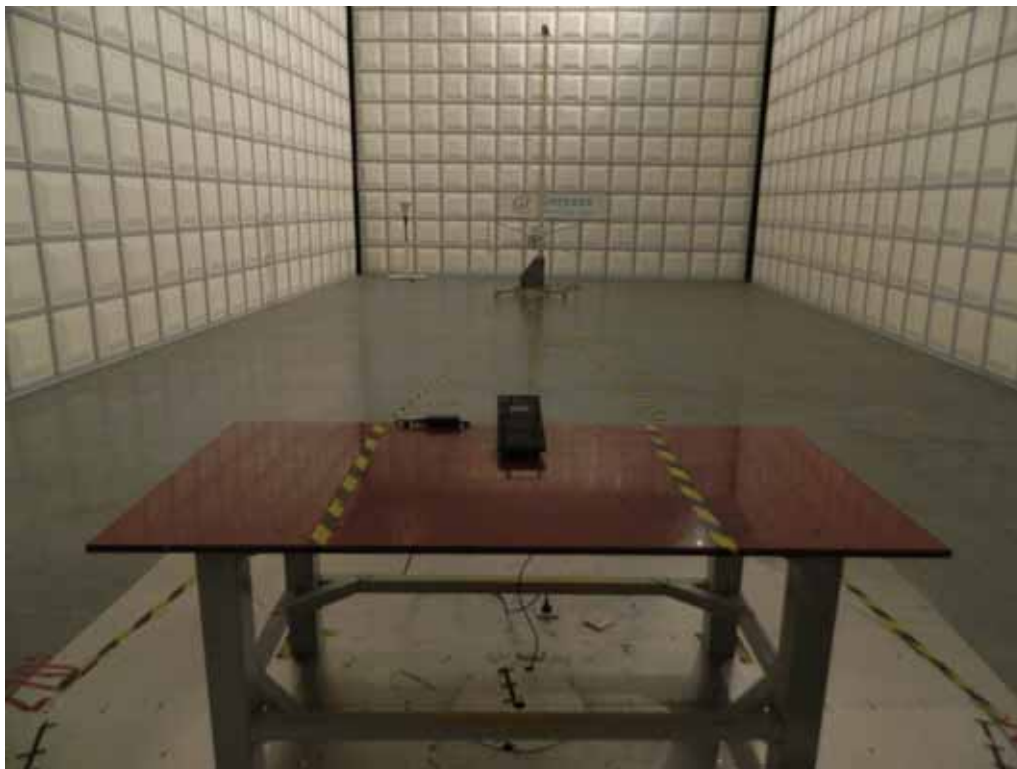

Rear View

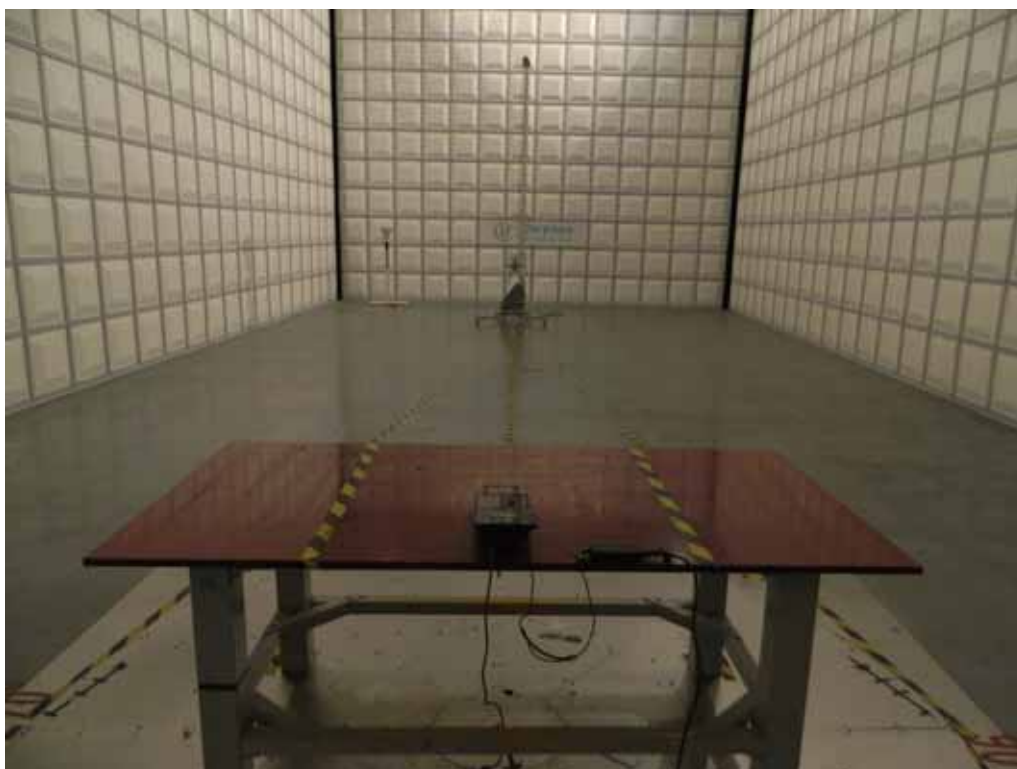



5.8. Test Photographs (1000MHz ~ 6000MHz)

Front View

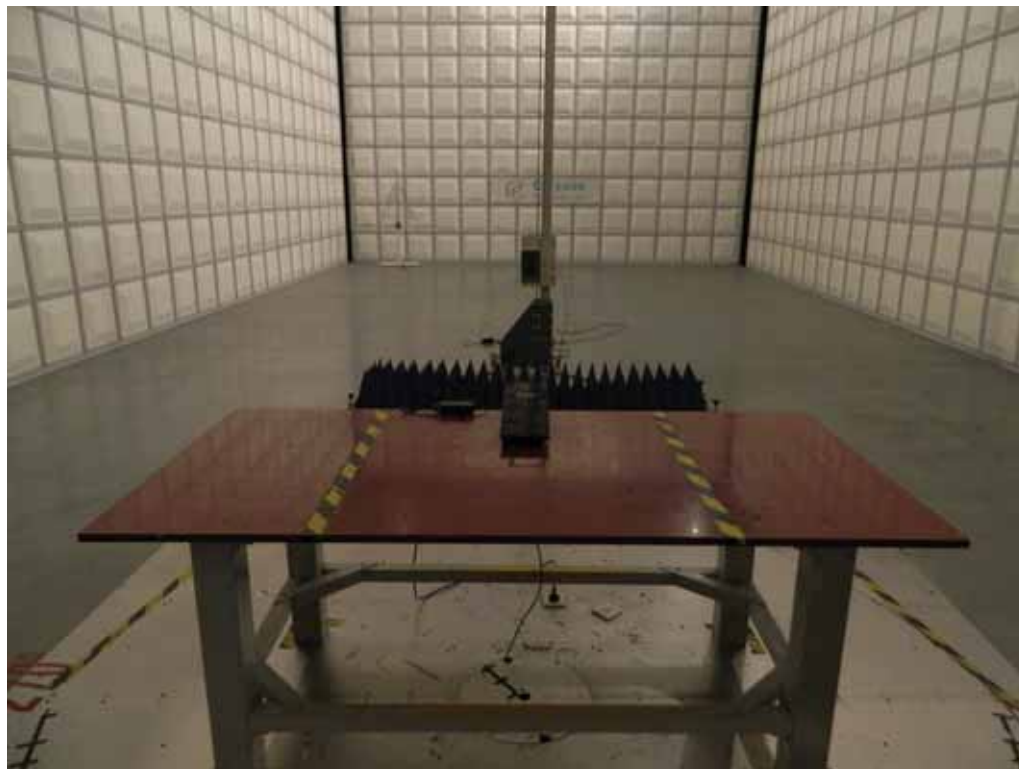

Rear View

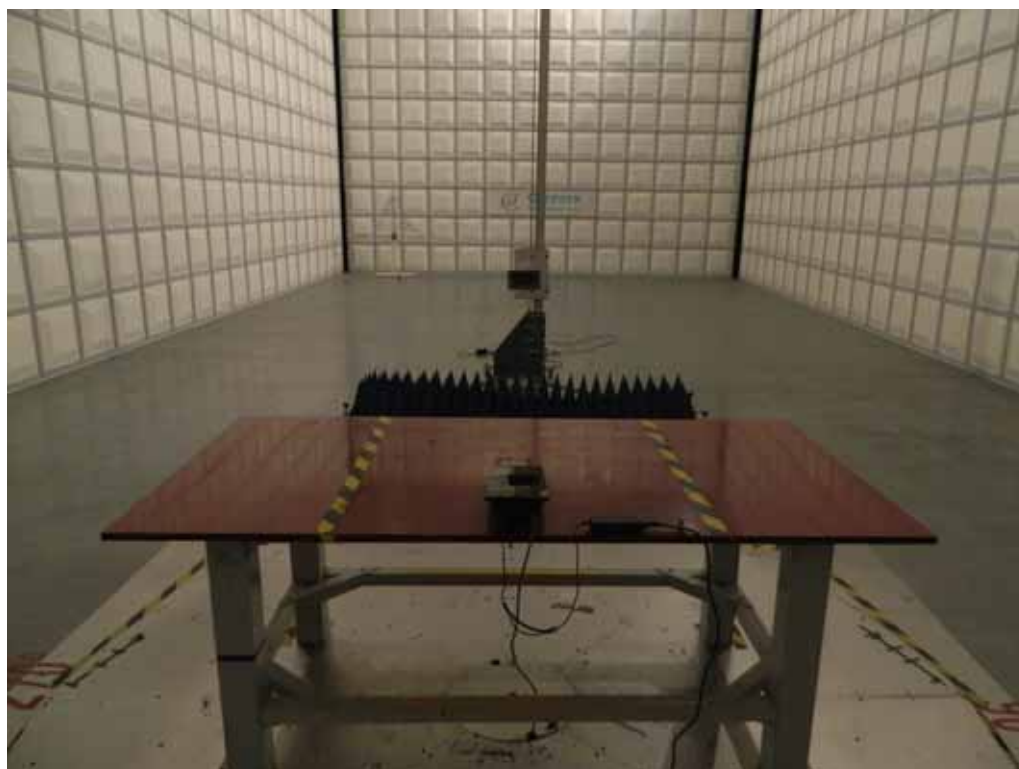



6. Harmonics Test

6.1. Limits of Harmonics Current Measurement

Limits for Class A equipment		Limits for Class D equipment		
Harmonics Order n	Max. Permissible harmonics current A	Harmonics Order n	Max. Permissible harmonics current per watt mA/W	Max. Permissible harmonics current A
Odd harmonics		Odd Harmonics only		
3	2.30	3	3.4	2.30
5	1.14	5	1.9	1.14
7	0.77	7	1.0	0.77
9	0.40	9	0.5	0.40
11	0.33	11	0.35	0.33
13	0.21	13	0.30	0.21
15<=n<=39	0.15×15/n	15<=n<=39	3.85/n	0.15 x15/n
Even harmonics				
2	1.08			
4	0.43			
6	0.30			
8<=n<=40	0.23×8/n			

6.2. Measurement equipment

Instrument/Ancillary	Manufacturer	Model No.	Serial No.	Calibration Date	Valid Date.
EMC Emission Tester	EMCPARTNER	Harmonics-1000	159	2012.04.20	2013.04.19
Temperature/Humidity Meter	Zhicheng	ZC1-11	CEP-TH-004	2013.03.10	2014.03.09



6.3. Test Result and Data

Basic Standard	:	EN 61000-3-2
Final Test Result	:	PASS
Test Mode	:	Mode 1: Normal Operation
Equipment	:	Outdoor Station
Model No.	:	DH-VTO
Temperature	:	20°C
Humidity	:	50 %
Atmospheric Pressure	:	100 kPa
Test Date	:	Apr 02, 2013

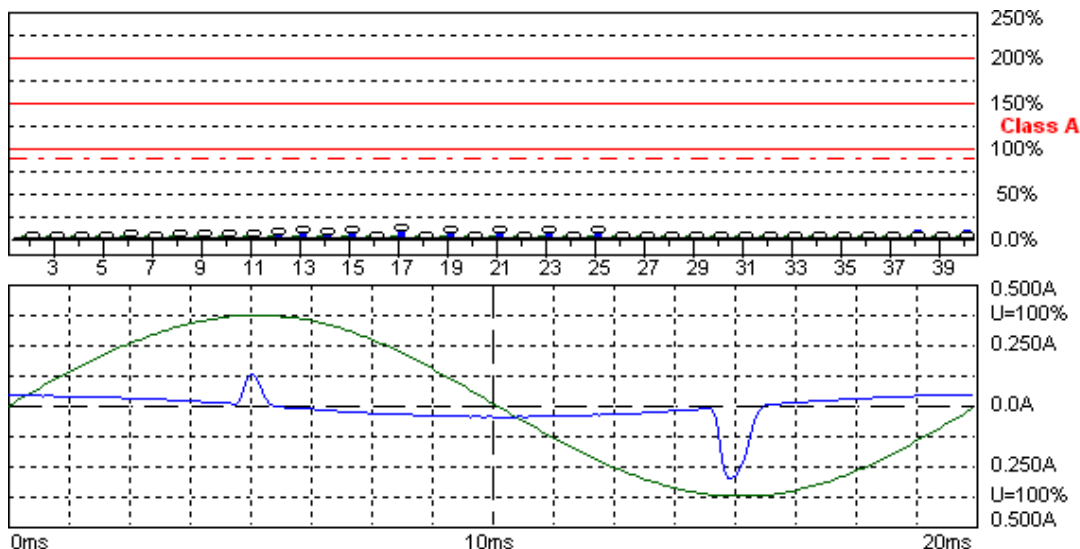

Harmonic Emission - IEC 61000-3-2, EN 61000-3-2, (EN60555-2)

2013-4-2 21:44:49 harmonic.hsu

Urms = 230.5 V P = 4.049 W THC = 0.048 A
 Irms = 0.059 A pf = 0.297

Range: 0.5 A
 V-nom: 230 V
 TestTime: 15 min (100%)

DH-VTD

Test completed, Result: PASSED

HAR-1000 EMC-Partner

Full Bar : Actual Values

Empty Bar : Maximum Values

Blue : Current , Green : Voltage , Red : Failed

Urms = 230.5V Freq = 50.000 Range: 0.5 A

Irms = 0.059A Ipk = 0.308A cf = 5.215

P = 4.049W S = 13.62VA pf = 0.297

THDi = 79.4 % THDu = 0.90 % Class A

Test - Time : 15min (100 %)

Test completed, Result: PASSED



6.1. Test Photographs





7. Voltage Fluctuations Test

7.1. Test Procedure

The equipment shall be tested under the conditions of **Clause 5**.

The total impedance of the test circuit, excluding the appliance under test, but including the internal impedance of the supply source, shall be equal to the reference impedance. The stability and tolerance of the reference impedance shall be adequate to ensure that the overall accuracy of $\pm 8\%$ is achieved during the whole assessment procedure.

7.2. Measurement equipment

Instrument/Ancillary	Manufacturer	Model No.	Serial No.	Calibration Date	Valid Date.
EMC Emission Tester	EMCPARTNER	Harmonics-1000	159	2012.04.20	2013.04.19
Temperature/ Humidity Meter	Zhicheng	ZC1-11	CEP-TH-004	2013.03.10	2014.03.09



7.3. Test Result and Data

Basic Standard	:	EN 61000-3-3
Final Test Result	:	PASS
Test Mode	:	Mode 1: Normal Operation
Equipment	:	Outdoor Station
Model No.	:	DH-VTO
Temperature	:	20°C
Humidity	:	50 %
Atmospheric Pressure	:	100 kPa
Test Data	:	Apr 02, 2013

Flickermeter 1000-4-15 for 230V/50Hz

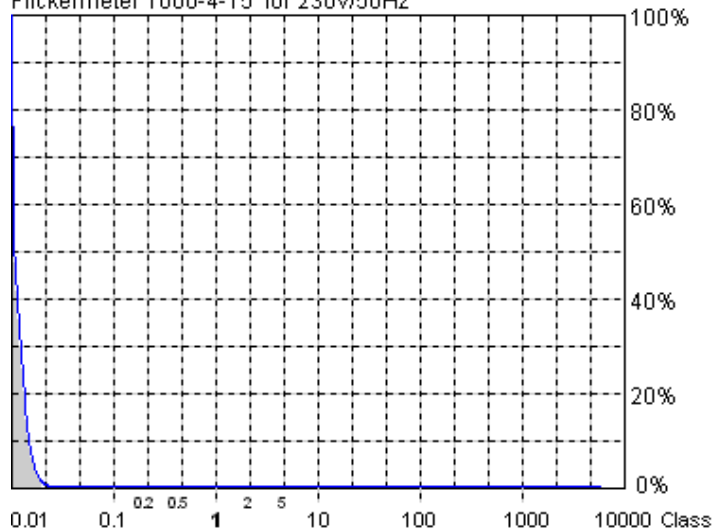

Actual Flicker (Fli): 0.01
Short-term Flicker (Pst): 0.09
 Limit (Pst): 1.00
Long-term Flicker (Pit): 0.09
 Limit (Pit): 0.65
Maximum Relative Volt. Change (dmax): 0.00%
 Limit (dmax): 4.00%
Relative Steady-state Voltage Change (dc): 0.12%
 Limit (dc): 3.30%
Maximum Interval exceeding 3.30% (dt): 0.00ms
 Limit (dt>Lim): 500ms

Flicker Emission - IEC 61000-3-3 , EN 61000-3-3 , (EN60555-3)

Urms = 230.5 V P = 4.062 W
 Irms = 0.059 A pf = 0.297

DH-VTD

Test completed, Result: PASSED

2013-4-2 22:00:00 harmonic.hsu

Range: 0.5 A
 V-nom: 230 V
 TestTime: 10 min (100%)

HAR-1000 EMC-Parber

- Full Bar : Actual Values
- Empty Bar : Maximum Values
- Circles : Average Values
- Blue : Current , Green : Voltage , Red : Failed



Urms = 230.5V Freq = 50.013 Range: 0.5 A
Irms = 0.059A Ipk = 0.312A cf = 5.251
P = 4.062W S = 13.67VA pf = 0.297

Test - Time : 1 x 10min = 10min (100 %)

LIN (Line Impedance Network) : No LIN

Limits : Plt : 0.65 Pst : 1.00
dmax : 4.00 % dc : 3.30 %
dtLim: 3.30 % dt>Lim: 500ms

Test completed, Result: PASSED

Test engineer: _____



7.4. Test Photographs





8. Electrostatic Discharge Immunity Test

8.1. Test Procedure

- a. In the case of air discharge testing the climatic conditions shall be within the following ranges:
 - ambient temperature: 15°C to 35°C;
 - relative humidity : 30% to 60%;
 - atmospheric pressure : 86 KPa (860 hPa) to 106 KPa (1060 hPa).
- b. Test programs and software shall be chosen so as to exercise all normal modes of operation of the EUT. The use of special exercising software is encouraged, but permitted only where it can be shown that the EUT is being comprehensively exercised.
- c. The test voltage shall be increased from the minimum to the selected test severity level, in order to determine any threshold of failure. The final severity level should not exceed the product specification value in order to avoid damage to the equipment.
- d. The test shall be performed with both air discharge and contact discharge. On reselected points at least 10 single discharges (in the most sensitive polarity) shall be applied on air discharge. On reselected points at least 25 single discharges (in the most sensitive polarity) shall be applied on contact discharge.
- e. For the time interval between successive single discharges an initial value of one second is recommended. Longer intervals may be necessary to determine whether a system failure has occurred.
- f. In the case of contact discharges, the tip of the discharge electrode shall touch the EUT before the discharge switch is operated.
- g. In the case of painted surface covering a conducting substrate, the following procedure shall be adopted :
 - ✧ If the coating is not declared to be an insulating coating by the equipment manufacturer, then the pointed tip of the generator shall penetrate the coating so as to make contact with the conducting substrate.
 - ✧ Coating declared as insulating by the manufacturer shall only be submitted to the air discharge.
 - ✧ The contact discharge test shall not be applied to such surfaces.
- h. In the case of air discharges, the round discharge tip of the discharge electrode shall be approached as fast as possible (without causing mechanical damage) to touch the EUT . After each discharge, the ESD generator (discharge electrode) shall be removed from the EUT. The generator is then retriggered for a new single discharge. This procedure shall be repeated until the discharges are completed. In the case of an air discharge test, the discharge switch, which is used for contact discharge, shall be closed.



8.2. Test Setup for Tests Performed in Laboratory

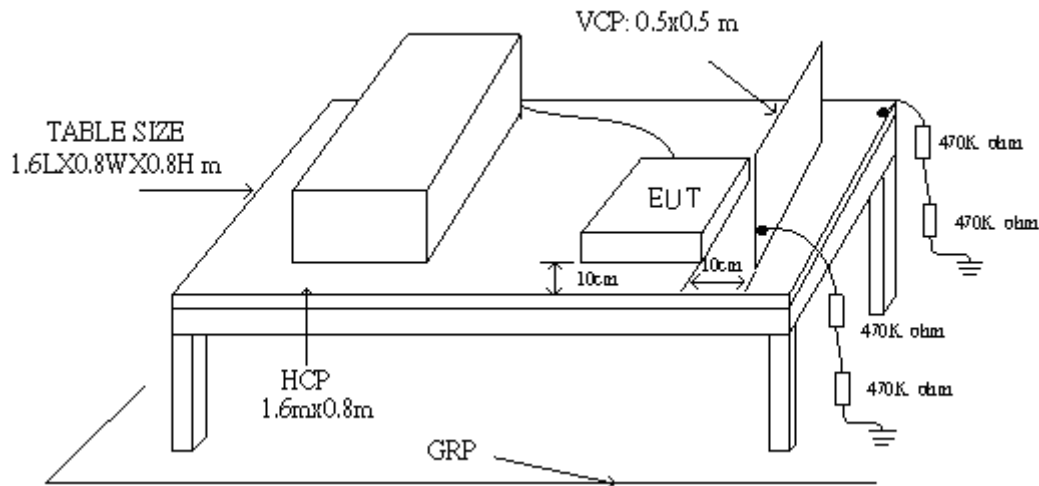

The test setup consists of the test generator, EUT and auxiliary instrumentation necessary to perform DIRECT and INDIRECT application of discharges to the EUT as applicable, in the follow manner :

- Contact Discharge to the conductive surfaces and to coupling plane;
- Air Discharge at insulating surfaces.

The preferred test method is that of type tests performed in laboratories and the only accepted method of demonstrating conformance with this standard. The EUT was arranged as closely as possible to arrangement in final installed conditions.

A ground reference plane was provided on the floor of the test site. It was a metallic sheet (copper or aluminum) of 0.25 mm, minimum thickness; other metallic may be used but they shall have at least 0.65 mm thickness. In the Exclusive Certification Corp., we provided 1 mm thickness stainless steel ground reference plane. The minimum size of the ground reference plane is 2.5 m x 2.5 m, the exact size depending on the dimensions of the EUT. It was connected to the protective grounding system.

The EUT was arranged and connected according to its functional requirements. A distance of 1m minimum was provided between the EUT and the wall of the lab. and any other metallic structure. In cases where this length exceeds the length necessary to apply the discharges to the selected points, the excess length shall, where possible, be placed non-inductively off the ground reference plane and shall not come closer than 0.2m to other conductive parts in the test setup.

Where the EUT is installed on a metal table, the table was connected to the reference plane via a cable with a 470k ohm resistor located at each end, to prevent a build-up of charge. The test setup was consist a wooden table, 0.8m high, standing on the ground reference plane. A HCP, 1.6 m x 0.8 m, was placed on the table. The EUT and cables was isolated from the HCP by an insulating support 0.5 mm thick. The VCP size, 0.5 m x 0.5 m.



8.3. Test Severity Levels

Contact Discharge		Air Discharge	
Level	Test Voltage (KV) of Contact discharge	Level	Test Voltage (KV) of Air Discharge
1	±2	1	±2
2	±4	2	±4
3	±6	3	±8
4	±8	4	±15
X	Specified	X	Specified

Remark: "X" is an open level.

8.4. Measurement equipment

Instrument/Ancillary	Manufacturer	Model No.	Serial No.	Calibration Date	Valid Date.
ESD Simulator	EM Test	ditto	V0714102399	2013.03.26	2014.03.25
ESD Simulator	EMC PARTNER	ESD3000	292	2013.02.01	2014.01.31
Tonometer	shanghaifengyun	DYM3	3251	2013.03.20	2014.03.19
Dehumidifier	ZEDO	ZD-220LB	CEP-TH-01	N/A	N/A
Humidifier	YADU	YZ-DS251C	CEP-TH-02	N/A	N/A
Temperature/ Humidity Meter	feiyun	N/A	102	2013.03.10	2014.03.09



8.5. Test Result and Data

Basic Standard : IEC 61000-4-2
 Product Standard : EN 50130-4: 2011
 Product Standard : EN 55024 : 2010
 Equipment : Outdoor Station
 Model No. : DH-VTO
 Final Test Result : PASS
 Temperature : 22°C
 Relative Humidity : 50%
 Atmospheric Pressure : 100 kPa
 Test Date : Mar 28, 2013

Test Mode 1: Normal Operation

For EN 55024: 2010

	Contact Discharge								Air Discharge							
	25 times / each								10 times / each							
Voltage	2 kV		4 kV		6 kV		8 kV		2 kV		4 kV		8 kV		10 kV	
Point\Polarity	+	-	+	-	+	-	+	-	+	-	+	-	+	-	+	-
HCP	A	A	A	A	---	---	---	---	---	---	---	---	---	---	---	---
VCP	A	A	A	A	---	---	---	---	---	---	---	---	---	---	---	---
Case	---	---	---	---	---	---	---	---	A	A	A	A	A	A	---	---
Screw	A	A	A	A	---	---	---	---	---	---	---	---	---	---	---	---
RJ45	A	A	A	A	---	---	---	---	---	---	---	---	---	---	---	---
Power Port	---	---	---	---	---	---	---	---	A	A	A	A	A	A	---	---

For EN 50130-4: 2011

Test Voltage: AC 230V/50Hz																
	Contact Discharge								Air Discharge							
	25 times / each								10 times / each							
Voltage	2 kV		4 kV		6 kV		8 kV		2 kV		4 kV		8 kV		10 kV	
Point\Polarity	+	-	+	-	+	-	+	-	+	-	+	-	+	-	+	-
HCP	A	A	A	A	A	A	---	---	---	---	---	---	---	---	---	---
VCP	A	A	A	A	A	A	---	---	---	---	---	---	---	---	---	---
Case	---	---	---	---	---	---	---	---	A	A	A	A	A	A	---	---
Screw	A	A	A	A	A	A	---	---	---	---	---	---	---	---	---	---
RJ45	A	A	A	A	A	A	---	---	---	---	---	---	---	---	---	---
Power Port	---	---	---	---	---	---	---	---	A	A	A	A	A	A	---	---



Test Voltage: AC 195.5V/50Hz																
	Contact Discharge								Air Discharge							
	25 times / each								10 times / each							
Voltage	2 kV		4 kV		6 kV		8 kV		2 kV		4 kV		8 kV		10 kV	
Point\Polarity	+	-	+	-	+	-	+	-	+	-	+	-	+	-	+	-
HCP	A	A	A	A	A	A	---	---	---	---	---	---	---	---	---	---
VCP	A	A	A	A	A	A	---	---	---	---	---	---	---	---	---	---
Case	---	---	---	---	---	---	---	---	A	A	A	A	A	A	---	---
Screw	A	A	A	A	A	A	---	---	---	---	---	---	---	---	---	---
RJ45	A	A	A	A	A	A	---	---	---	---	---	---	---	---	---	---
Power Port	---	---	---	---	---	---	---	---	A	A	A	A	A	A	---	---

Test Voltage: AC 253V/50Hz																
	Contact Discharge								Air Discharge							
	25 times / each								10 times / each							
Voltage	2 kV		4 kV		6 kV		8 kV		2 kV		4 kV		8 kV		10 kV	
Point\Polarity	+	-	+	-	+	-	+	-	+	-	+	-	+	-	+	-
HCP	A	A	A	A	A	A	---	---	---	---	---	---	---	---	---	---
VCP	A	A	A	A	A	A	---	---	---	---	---	---	---	---	---	---
Case	---	---	---	---	---	---	---	---	A	A	A	A	A	A	---	---
Screw	A	A	A	A	A	A	---	---	---	---	---	---	---	---	---	---
RJ45	A	A	A	A	A	A	---	---	---	---	---	---	---	---	---	---
Power Port	---	---	---	---	---	---	---	---	A	A	A	A	A	A	---	---

Test engineer: *Cebew*



8.6. Test Photographs

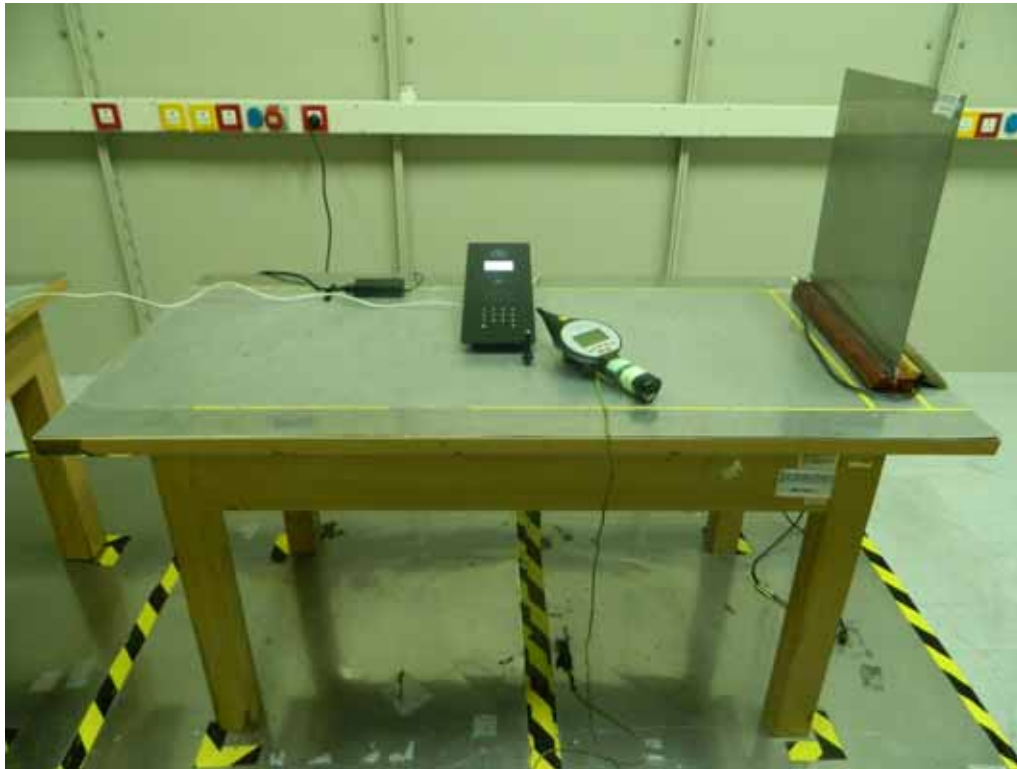



9. Radio Frequency electromagnetic field immunity test

9.1. Test Procedure

- a. The equipment to be tested is placed in the center of the enclosure on a wooden table. The equipment is then connected to power and signal leads according to pertinent installation instructions.
- b. The required field strength is determined by placing the field strength meter(s) on top of or directly alongside the equipment under test and monitoring the field strength meter via a remote field strength indicator outside the enclosure while adjusting the continuous-wave to the applicable antennae.
- c. The test is normally performed with the antenna facing the most sensitive side of the EUT. The polarization of the field generated by the bucolical antenna necessitates testing each position twice, once with the antenna positioned vertically and again with the antenna positioned horizontally. The circular polarization of the field from the log-spiral antenna makes a change of position of the antenna unnecessary.
- d. At each of the above conditions, the frequency range is swept 80-2700 MHz, pausing to adjust the R.F. signal level or to switch oscillators and antenna. The rate of sweep is in the order of 1.5×10^{-3} decades/s. The sensitive frequencies or frequencies of dominant interest may be discretely analyzed.



9.2. Test Severity Levels

	Condition of Test	Remarks
1.	Field Strength	10 V/m
2.	Radiated Signal	AM 80% Modulated with 1kHz Pulse modulation 1Hz (0.5s ON; 0.5s OFF)
3.	Scanning Frequency	80MHz - 2700MHz
4.	Dwell Time	3 Seconds
5.	Frequency step size Δf :	1%
6.	The rate of Swept of Frequency	1.5 x 10 ⁻³ decades/s

9.3. Measurement equipment

Instrument/Ancillary	Manufacturer	Model No.	Serial No.	Calibration Date	Valid Date.
Signal Generator	R&S	SML03	103287	2013.03.10	2014.03.09
Power Sensor	R&S	NR P-Z91	100383	2013.03.10	2014.03.09
Power Sensor	R&S	NRP-Z91	100384	2013.03.10	2014.03.09
Power Meter	R&S	NRP	101206	2013.03.10	2014.03.09
Power Amplifier	BONN	BLWA0830-16 0/100/40D	076659	2013.03.10	2014.03.09
Istropic Electric Field Probe	EST.LINDGRE N	HI-6105	137445	2012.09.26	2013.09.25
EMS Antenna	R&S	HL046E	100028	N/A	N/A
Temperature/ Humidity Meter	feiyang	N/A	101	2013.03.10	2014.03.09



9.4. Test Result and Data

Basic Standard : IEC 61000-4-3
 Product Standard : EN 50130-4: 2011
 Product Standard : EN 55024 : 2010
 Equipment : Outdoor Station
 Model No. : DH-VTO
 Final Test Result : PASS
 Temperature : 20°C
 Relative Humidity : 50%
 Atmospheric Pressure : 100 kPa
 Test Date : Mar 28, 2013

Test Mode 1: Normal Operation

For EN 55024: 2010

Modulation : AM 80% , 1KHz sine wave , Dwell time: 3.0 S				
Frequency Step Size : 1 % of preceding frequency value				
Frequency (MHz)	Antenna Polarization	face	Field strength (V/m)	Result
80~1000	Vertical	Front	3 V/m	A
80~1000	Vertical	Rear	3 V/m	A
80~1000	Vertical	Left	3 V/m	A
80~1000	Vertical	Right	3 V/m	A
80~1000	Horizontal	Front	3 V/m	A
80~1000	Horizontal	Rear	3 V/m	A
80~1000	Horizontal	Left	3 V/m	A
80~1000	Horizontal	Right	3 V/m	A



For EN 50130-4: 2011

Test Voltage: AC 230V/50Hz

Modulation : AM 80% , 1KHz sine wave , Dwell time: 3.0S				
Frequency Step Size : 1 % of preceding frequency value				
Frequency (MHz)	Antenna Polarization	face	Field strength (V/m)	Result
80~2700	Horizontal &Vertical	Front	10 V/m	A
80~2700	Horizontal &Vertical	Rear	10 V/m	A
80~2700	Horizontal &Vertical	Left	10 V/m	A
80~2700	Horizontal &Vertical	Right	10 V/m	A

Test Voltage: AC 195.5V/50Hz

Modulation : AM 80% , 1KHz sine wave , Dwell time: 3.0 S				
Frequency Step Size : 1 % of preceding frequency value				
Frequency (MHz)	Antenna Polarization	face	Field strength (V/m)	Result
80~2700	Horizontal &Vertical	Front	10 V/m	A
80~2700	Horizontal &Vertical	Rear	10 V/m	A
80~2700	Horizontal &Vertical	Left	10 V/m	A
80~2700	Horizontal &Vertical	Right	10 V/m	A

Test Voltage: AC 253V/50Hz

Modulation : AM 80% , 1KHz sine wave , Dwell time: 3.0 S				
Frequency Step Size : 1 % of preceding frequency value				
Frequency (MHz)	Antenna Polarization	face	Field strength (V/m)	Result
80~2700	Horizontal &Vertical	Front	10 V/m	A
80~2700	Horizontal &Vertical	Rear	10 V/m	A
80~2700	Horizontal &Vertical	Left	10 V/m	A
80~2700	Horizontal &Vertical	Right	10 V/m	A

Test engineer:



9.5. Test Photographs

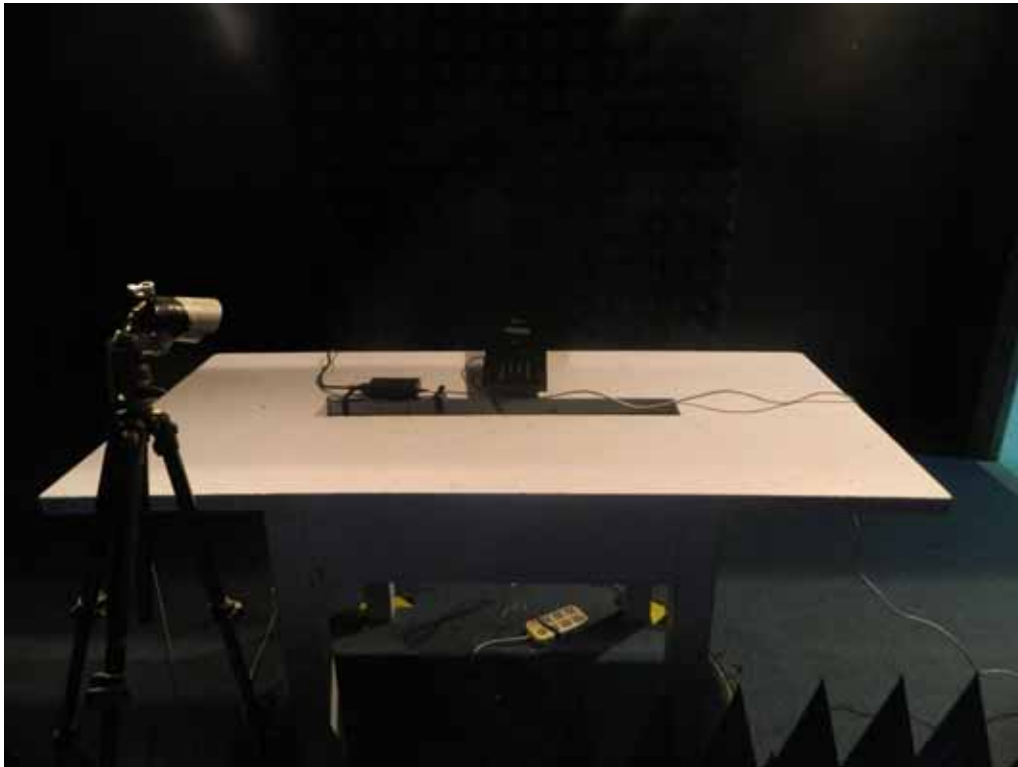



10. Electrical Fast Transient/ Burst Immunity Test

10.1. Test Procedure

- a. In order to minimize the effect of environmental parameters on test results, the climatic conditions when test is carrying out shall comply with the following requirements:
 - ✧ ambient temperature: 15°C to 35°C;
 - ✧ relative humidity : 45% to 75%;
 - ✧ Atmospheric pressure: 86 Kpa (860 hPa) to 106 Kpa (1060 hPa).
- b. In order to minimize the effect of environmental parameters on test results, the electromagnetic environment of the laboratory shall not influence the test results.
- c. The variety and diversity of equipment and systems to be tested make it difficult to establish general criteria for the evaluation of the effects of fast transients/bursts on equipment and systems.
- d. Test on Power Line:
 - ✧ The EFT/B-generator was located on the GRP.. The length from the EFT/B-generator to the EUT is not exceeding 1 m.
 - ✧ The EFT/B-generator provides the ability to apply the test voltage in a non-symmetrical condition to the power supply input terminals of the EUT.
- e. Test on Communication Lines
 - ✧ The coupling clamp is composed of a clamp unit for housing the cable (length more than 3 m), and was placed on the GRP.
 - ✧ The coupling clamp provides the ability of coupling the fast transient/bursts to the cable under test.
- f. The test results may be classified on the basic of the operating conditions and the functional specification of the equipment under test, according to the following performance criteria :
 - ✧ Normal performance within the specification limits.
 - ✧ Temporary degradation or loss of function or performance which is self-recoverable.
 - ✧ Temporary degradation or loss of function or performance which requires operator intervention or system reset.
 - ✧ Degradation or loss of function which is not recoverable due to damage of equipment (components).



10.2. Test Severity Levels

The following test severity levels are recommended for the fast transient/burst test :

Open circuit output test voltage $\pm 10\%$		
Level	On Power Supply	On I/O signal, data and control line
1	0.5 KV	0.25 KV
2	1.0 KV	0.50 KV
3	2.0 KV	1.00 KV
4	4.0 KV	2.00 KV
X	Specified	Specified

Remark : " X " is an open level. The level is subject to negotiation between the user and the manufacturer or is specified by the manufacturer.

10.3. Measurement equipment

Instrument/Ancillary	Manufacturer	Model No.	Serial No.	Calibration Date	Valid Date.
TRANSIENT	EMCPARTNER	TRA2000IN6	901	2013.03.10	2014.03.09
CDN	EMCPARTNER	CDN200-06-32	121	2013.03.10	2014.03.09
Coupling clamp	EMCPARTNER	CN-EFT1000	547	2013.03.10	2014.03.09
Temperature/ Humidity Meter	Zhicheng	ZC1-11	CEP-TH-005	2013.03.10	2014.03.09



10.4. Test Result and Data

Basic Standard : IEC 61000-4-4
 Product Standard : EN 50130-4: 2011
 Product Standard : EN 55024 : 2010
 Equipment : Outdoor Station
 Model No. : DH-VTO
 Final Test Result : PASS
 Temperature : 21°C
 Relative Humidity : 51%
 Atmospheric Pressure : 100 kPa
 Test Date : Mar 28, 2013

Test Mode 1: Normal Operation
 For EN 55024: 2010

Pulse : 5/50 ns		Repetition Rate: <u>5 kHz</u> above 2.0 kV			
Burst : 15m/300ms		5 <u>kHz</u> below and equal 2.0 kV			
Test time : 1 min/each condition					
Voltage/ Mode/ Polarity/ Result/ Phase		<u>0.5 kV</u>		<u>1.0 kV</u>	
		+	-	+	-
Power Line	L	---	---	A	A
	N	---	---	A	A
	L-N	---	---	A	A
	PE	---	---	A	A
	L-PE	---	---	A	A
	N-PE	---	---	A	A
	L-N-PE	---	---	A	A
Signal Line	RJ 45	A	A	---	---



For EN 50130-4: 2011

Test Voltage: AC 230V/50Hz

Pulse : 5/50 ns		Repetition Rate: 5/100 kHz above 2.0 kV			
Burst : 15m/300ms		5/100 kHz below and equal 2.0 kV			
Test time : 1 min/each condition					
Voltage/ Mode/ Polarity/ Result/ Phase		<u>1.0 kV</u>		<u>2.0 kV</u>	
		+	-	+	-
Power Line	L	---	---	A	A
	N	---	---	A	A
	L-N	---	---	A	A
	PE	---	---	A	A
	L-PE	---	---	A	A
	N-PE	---	---	A	A
	L-N-PE	---	---	A	A
Signal Line	RJ 45	A	A	---	---

Test Voltage: AC 195.5V/50Hz

Pulse : 5/50 ns		Repetition Rate: 5/100 kHz above 2.0 kV			
Burst : 15m/300ms		5/100 kHz below and equal 2.0 kV			
Test time : 1 min/each condition					
Voltage/ Mode/ Polarity/ Result/ Phase		<u>1.0 kV</u>		<u>2.0 kV</u>	
		+	-	+	-
Power Line	L	---	---	A	A
	N	---	---	A	A
	L-N	---	---	A	A
	PE	---	---	A	A
	L-PE	---	---	A	A
	N-PE	---	---	A	A
	L-N-PE	---	---	A	A
Signal Line	RJ 45	A	A	---	---



Test Voltage: AC 253V/50Hz

Pulse : 5/50 ns		Repetition Rate: 5/100 kHz above 2.0 kV			
Burst : 15m/300ms		5/100 kHz below and equal 2.0 kV			
Test time : 1 min/each condition					
Voltage/ Mode/ Polarity/ Result/ Phase		<u>1.0 kV</u>		<u>2.0 kV</u>	
		+	-	+	-
Power Line	L	---	---	A	A
	N	---	---	A	A
	L-N	---	---	A	A
	PE	---	---	A	A
	L-PE	---	---	A	A
	N-PE	---	---	A	A
	L-N-PE	---	---	A	A
Signal Line	RJ 45	A	A	---	---

Test engineer: Seben



10.5. Test Photographs

Main Port



LAN Port





11. Surge Immunity Test

11.1. Test Procedure

a. Climatic conditions

The climatic conditions shall comply with the following requirements :

- ✧ ambient temperature : 15 °C to 35 °C
- ✧ relative humidity : 10 % to 75 %
- ✧ atmospheric pressure : 86 kPa to 106 kPa (860 hPa to 1060 hPa)

b. Electromagnetic conditions

the electromagnetic environment of the laboratory shall not influence the test results.

c. The test shall be performed according the test plan that shall specify the test set-up with

- ✧ generator and other equipment utilized;
- ✧ test level (voltage/current);
- ✧ generator source impedance;
- ✧ internal or external generator trigger;
- ✧ number of tests : at least five positive and five negative at the selected points;
- ✧ repetition rate : maximum 1/min.
- ✧ inputs and outputs to be tested;
- ✧ representative operating conditions of the EUT;
- ✧ sequence of application of the surge to the circuit;
- ✧ phase angle in the case of AC. power supply;
- ✧ actual installation conditions, for example :

AC : neutral earthed,

DC : (+) or (-) earthed to simulated the actual earthing conditions.

- d. If not otherwise specified the surges have to be applied synchronized to the voltage phase at the zero-crossing and the peak value of the AC. voltage wave (positive and negative).
- e. The surges have to be applied line to line and line(s) and earth. When testing line to earth, the test voltage has to be applied successively between each of the lines and earth, if there is no other specification.
- f. The test procedure shall also consider the non-linear current-voltage characteristics of the equipment under test. Therefore the test voltage has to be increased by steps up to the test level specified in the product standard or test plan.
- g. All lower levels including the selected test level shall be satisfied. For testing the secondary protection, the output voltage of the generator shall be increased up to the worst-case voltage breakdown level (let-through level) of the primary protection.
- h. If the actual operating signal sources are not available, that may be simulated. Under no circumstances may the test level exceed the product specification. The test shall be carried out according to a test plan.
- i. To find all critical points of the duty cycle of the equipment, a sufficient number of positive and negative test pulses shall be applied. For acceptance test previously unstressed equipment shall be used to the protection devices shall be replaced.



11.2. Test Severity Level

Level	Open-circuit test voltage, $\pm 10\%$, KV
1	0.5
2	1.0
3	2.0
4	4.0
X	Specified

NOTE: "X" is an open class. This level can be specified in the product specification.

11.3. Measurement equipment

Instrument/Ancillary	Manufacturer	Model No.	Serial No.	Calibration Date	Valid Date.
TRANSIENT	EMCPARTNER	TRA2000IN6	901	2013.03.10	2014.03.09
CDN	EMCPARTNER	CDN-UTP8	021	2013.03.10	2014.03.09
CDN	EMCPARTNER	CDN200-06-32	121	2013.03.10	2014.03.09
Temperature/ Humidity Meter	Zhicheng	ZC1-11	CEP-TH-005	2013.03.10	2014.03.09

**11.4. Test Result and Data**

Basic Standard	:	IEC 61000-4-5
Product Standard	:	EN 50130-4: 2011
Product Standard	:	EN 55024 : 2010
Equipment	:	Outdoor Station
Model No.	:	DH-VTO
Final Test Result	:	PASS
Temperature	:	21°C
Relative Humidity	:	51%
Atmospheric Pressure	:	100 kPa
Test Date	:	Mar 28, 2013

Test Mode 1: Normal Operation

For EN 55024: 2010

Power Port

Waveform : 1.2/50µs(8/20µs) Repetition rate : 60 sec Time : 20 time/each condition						
/Phase Voltage / Mode / Polarity / Result			0°	90°	180°	270°
<u>0.5/1.0 kV</u>	L-N	+	A	A	A	A
		-	A	A	A	A
<u>0.5/1.0/2.0kV</u>	L-PE	+	A	A	A	A
		-	A	A	A	A
	N-PE	+	A	A	A	A
		-	A	A	A	A

Waveform :10/700µs Repetition rate : 60 sec Time : 5 time/each condition				
Voltage	<u>0.5 kV</u>		<u>1.0 kV</u>	
Mode / Polarity / Result	+	-	+	-
RJ45	A	A	A	A



For EN 50130-4: 2011

Power Port

Test Voltage: AC 230V/50Hz						
Waveform : 1.2/50µs(8/20µs) Repetition rate : 60 sec Time : 20 time/each condition						
/Phase Voltage / Mode / Polarity / Result			0°	90°	180°	270°
<u>0.5/1.0</u> kV	L-N	+	A	A	A	A
		-	A	A	A	A
<u>0.5/1.0/2.0</u> kV	L-PE	+	A	A	A	A
		-	A	A	A	A
	N-PE	+	A	A	A	A
		-	A	A	A	A

Waveform : 1.2/50µs(8/20µs) Repetition rate : 60 sec Time : 5 time/each condition				
Voltage	<u>0.5</u> kV		<u>1.0</u> kV	
Mode / Polarity / Result	+	-	+	-
RJ45	A	A	A	A

Waveform : 10/700µs Repetition rate : 60 sec Time : 5 time/each condition				
Voltage	<u>0.5</u> kV		<u>1.0</u> kV	
Mode / Polarity / Result	+	-	+	-
RJ45	A	A	A	A

**Power Port**

Test Voltage: AC 195.5V/50Hz						
Waveform : 1.2/50 μ s(8/20 μ s) Repetition rate : 60 sec Time : 20 time/each condition						
/Phase Voltage / Mode / Polarity / Result			0°	90°	180°	270°
<u>0.5/1.0 kV</u>	L-N	+	A	A	A	A
		-	A	A	A	A
<u>0.5/1.0/2.0kV</u>	L-PE	+	A	A	A	A
		-	A	A	A	A
	N-PE	+	A	A	A	A
		-	A	A	A	A

Waveform : 1.2/50 μ s(8/20 μ s) Repetition rate : 60 sec Time : 5 time/each condition				
Voltage	<u>0.5 kV</u>		<u>1.0 kV</u>	
Mode / Polarity / Result	+	-	+	-
RJ45	A	A	A	A

Waveform : 10/700 μ s Repetition rate : 60 sec Time : 5 time/each condition				
Voltage	<u>0.5 kV</u>		<u>1.0 kV</u>	
Mode / Polarity / Result	+	-	+	-
RJ45	A	A	A	A



Power Port

Test Voltage: AC 253V/50Hz						
Waveform : 1.2/50µs(8/20µs) Repetition rate : 60 sec Time : 20 time/each condition						
/Phase Voltage / Mode / Polarity / Result			0°	90°	180°	270°
<u>0.5/1.0 kV</u>	L-N	+	A	A	A	A
		-	A	A	A	A
<u>0.5/1.0/2.0kV</u>	L-PE	+	A	A	A	A
		-	A	A	A	A
	N-PE	+	A	A	A	A
		-	A	A	A	A

Waveform : 1.2/50µs(8/20µs) Repetition rate : 60 sec Time : 5 time/each condition				
Voltage	<u>0.5 kV</u>		<u>1.0 kV</u>	
Mode / Polarity / Result	+	-	+	-
RJ45	A	A	A	A

Waveform : 10/700µs Repetition rate : 60 sec Time : 5 time/each condition				
Voltage	<u>0.5 kV</u>		<u>1.0 kV</u>	
Mode / Polarity / Result	+	-	+	-
RJ45	A	A	A	A

Test engineer: Seben



11.5. Test Photographs

Main Port



LAN Port





12. Conduction Disturbances induced by Radio-Frequency Fields

12.1. Test Procedure

- a. The EUT shall be operated within its intended climatic conditions. The temperature and relative humidity should be recorded.
- b. This test method test can be performed without using a sell shielded enclosure. This is because the disturbance levels applied and the geometry of the setups are not likely to radiated a high amount of energy, especially at the lower frequencies. If under certain circumstances the radiated energy is too high, a shielded enclosure has to be used.
- c. The test shall be performed with the test generator connected to each of the coupling and decoupling devices in turn while the other non-excited RF-input ports of the coupling devices are terminated by a 50 ohm load resistor.
- d. The frequency range is swept from 150 KHZ to 100 MHz, using the signal levels established during the setting process, and with the disturbance signal 80% amplitude modulated with a 1KHz sign wave, pausing to adjust the RF-signal level or to switch coupling devices as necessary. The rate of sweep shall no exceed 1.5×10^{-3} decades/s. Where the frequency is swept incrementally, the step size shall no exceed 1% of the start and thereafter 1% of the preceding frequency value.
- e. The dwell time at each frequency shall not be less than the time necessary for the EUT to be exercised, and able to respond. Sensitive frequencies e.g. clock frequency (ies) and harmonics or frequencies of dominant interest shall be analyzed separately.
- f. An alternative test procedure may be adopted, wherein the frequency range is swept incrementally, with a step size not exceeding 4% of the start ad thereafter 4% of the preceding frequency value. The test level should be at least twice the value of the specified test level.
- g. In cases of dispute, the test procedure using a step size not exceeding 1% of the start and thereafter 1% of preceding frequency value shall take precedence.
- h. Attempts should be made to fully exercise the EUT during testing, and to fully interrogate all exercise modes selected for susceptibility.
- i. The use of special exercising programs is recommended.
- j. Testing shall be performed according to a Test Plan, which shall be included in the test report.
- k. It may be necessary to carry out some investigatory testing in order to establish some aspects of the test plan.



12.2. Test Severity Levels

Level	Voltage Level (EMF),
1	1 V
2	3 V
3	10 V
x	Specified
NOTE - x is an open class. This level can be specified in the product specification.	

12.3. Measurement equipment

Instrument/Ancillary	Manufacturer	Model No.	Serial No.	Calibration Date	Valid Date.
Conducted immunity test system	FRANKONIA	CIT-10/75	102D1294	2013.03.10	2014.03.09
EM Injection clamp	FCC	F-203I-23MM	536	2013.03.10	2014.03.09
CDN	FRANKONIA	CDN-T2	A3010029	2013.03.10	2014.03.09
CDN	FRANKONIA	CDN-T4	A3015017	2013.03.10	2014.03.09
CDN	FRANKONIA	CDN-T8	A3022010	2013.03.10	2014.03.09
CDN	FRANKONIA	CDN-M2	A3002037	2013.03.10	2014.03.09
CDN	FRANKONIA	CDN-M2+M3	A3011102	2013.03.10	2014.03.09
CDN	FCC	CDN-M5/32	A3013024	2013.03.10	2014.03.09
6 dB Attenuator	FRANKONIA	N/A	N/A	2013.03.10	2014.03.09
Temperature/ Humidity Meter	Zhicheng	ZC1-11	CEP-TH-005	2013.03.10	2014.03.09



12.4. Test Result and Data

Basic Standard : IEC 61000-4-6
 Product Standard : EN 50130-4: 2011
 Product Standard : EN 55024 : 2010
 Equipment : Outdoor Station
 Model No. : DH-VTO
 Final Test Result : PASS
 Temperature : 21°C
 Relative Humidity : 51%
 Atmospheric Pressure : 100 kPa
 Test Date : Mar 28, 2013

Test Mode 1: Normal Operation

For EN 55024: 2010

Frequency : 0.15~80MHz, Modulation : AM 80%,1KHz sine wave, Dwell time: 2.9s Frequency Step Size : 1 % of preceding frequency value			
Frequency	Test mode	Voltage(V)	Result
0.15 ~ 80MHz	Power(M3)	3	A
0.15 ~ 80MHz	RJ45	3	A

For EN 50130-4: 2011

Test Voltage: AC 230V/50Hz

Frequency : 0.15~100MHz, Modulation : AM 80%,1KHz sine wave, Dwell time: 2.9s Frequency Step Size : 1 % of preceding frequency value			
Frequency	Test mode	Voltage(V)	Result
0.15 ~ 100MHz	Power(M3)	10	A
0.15 ~ 100MHz	RJ45	10	A



Test Voltage: AC 195.5V/50Hz

Frequency : 0.15~100MHz, Modulation : AM 80%,1KHz sine wave, Dwell time: 2.9s			
Frequency Step Size : 1 % of preceding frequency value			
Frequency	Test mode	Voltage(V)	Result
0.15 ~ 100MHz	Power(M3)	10	A
0.15 ~ 100MHz	RJ45	10	A

Test Voltage: AC 253V/50Hz

Frequency : 0.15~100MHz, Modulation : AM 80%,1KHz sine wave, Dwell time: 2.9s			
Frequency Step Size : 1 % of preceding frequency value			
Frequency	Test mode	Voltage(V)	Result
0.15 ~ 100MHz	Power(M3)	10	A
0.15 ~ 100MHz	RJ45	10	A

Test engineer: Seben



12.5. Test Photographs

Main Port



LAN Port





13. Power Frequency Magnetic Field Immunity Tests

13.1. Test Setup

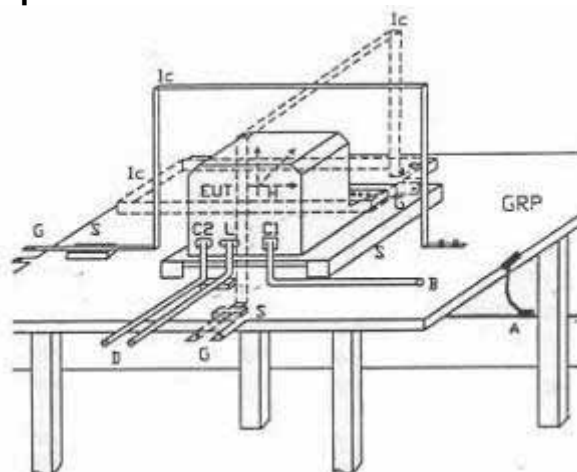

GPR	: Ground plane	C1	: Power supply circuit
A	: Safety earth	C2	: Signal circuit
S	: Insulating support	L	: Communication line
EUT	: Equipment under test	B	: To power supply source
Lc	: Induction coil	D	: To signal source, simulator
E	: Earth terminal	G	: To the test generator

13.1. Test Severity Levels

Level	Magnetic field strength A/m
1	1
2	3
3	10
4	30
5	100
X ¹⁾	special

NOTE 1 "X" is an open level. This level can be given in the product specification.

13.1. Measurement equipment

Instrument/Ancillary	Manufacturer	Model No.	Serial No.	Calibration Date	Valid Date.
TRANSIENT	EMCPARTNER	TRA2000IN6	901	2013.03.10	2014.03.09
H-Filed-Loop	EMCPARTNER	MF1000-1	144	2013.03.10	2014.03.09
Temperature/ Humidity Meter	Zhicheng	ZC1-11	CEP-TH-005	2013.03.10	2014.03.09



13.1. Test Result and Data

Basic Standard : IEC 61000-4-8
Product Standard : EN 55024 : 2010
Equipment : Outdoor Station
Model No. : DH-VTO
Final Test Result : PASS
Temperature : 21°C
Relative Humidity : 51%
Atmospheric Pressure : 100 kPa
Test Date : Mar 28, 2013

Test Mode 1: Normal Operation

Power Frequency Magnetic Field : <u>50</u> Hz, <u>1</u> A/m		
Coil Orientation	Testing duration	Results
X-axis	1.0 Min	A
Y-axis	1.0 Min	A
Z-axis	1.0 Min	A

Test engineer: Seben



13.2. Test Photographs





14. Voltage Dips and Voltage Interruptions Immunity Test Setup

14.1. Test Conditions

1. Source voltage and frequency : 230V / 50Hz, Single phase.
2. Test of interval : 10 sec.
3. Level and duration : Sequence of 3 dips/interrupts.
4. Voltage rise (and fall) time : 1 ~ 5 μ s.
5. Test severity :

Voltage dips and Interrupt reduction (%)	Test Duration (period)
>95%	250
30%	25
>95%	0.5

Item	Environmental Phenomena	Units	Test Specification	Performance Criteria
Input AC Power Ports				
Voltage Dips		% Reduction	20	
		period	250	
		% Reduction	30	
		period	25	
		% Reduction	60	
		period	10	
Voltage Interruptions		% Reduction	100	
		period	250	

14.2. Measurement equipment

Instrument/Ancillary	Manufacturer	Model No.	Serial No.	Calibration Date	Valid Date.
TRANSIENT	EMCPARTNER	TRA2000IN6	901	2013.03.10	2014.03.09
Temperature/ Humidity Meter	Zhicheng	ZC1-11	CEP-TH-005	2013.03.10	2014.03.09



14.3. Test Result and Data

Basic Standard : IEC 61000-4-11
 Product Standard : EN 50130-4: 2011
 Product Standard : EN 55024 : 2010
 Equipment : Outdoor Station
 Model No. : DH-VTO
 Final Test Result : PASS
 Temperature : 21 °C
 Relative Humidity : 51%
 Atmospheric Pressure : 100 kPa
 Test Date : Mar 28, 2013

Test Mode 1: Normal Operation

For EN 55024: 2010

Test Voltage: AC 230V/50Hz										
Interval(s) : 10s Times : 3										
Test mode	Test level reduction %	Durations (period / ms)	Phase / Result							
			0	45	90	135	180	225	270	315
Voltage interruptions	>95%	250	C	C	C	C	C	C	C	C
Voltage dips	30%	25	B	B	B	B	B	B	B	B
	>95%	0.5	B	B	B	B	B	B	B	B



For EN 50130-4: 2011

Test Voltage: AC 230V/50Hz										
Voltage(UT): AC 230 V 50 Hz Interval(s) : 10s Times : 3										
Test mod	Test level UT %	Durations (period / ms)	Phase / Result							
			0	45	90	135	180	225	270	315
Voltage interruptions	100%	250	C	C	C	C	C	C	C	C
Voltage dips	20%	250	C	C	C	C	C	C	C	C
	30%	25	B	B	B	B	B	B	B	B
	60%	10	B	B	B	B	B	B	B	B

Test Voltage: AC 195.5V/50Hz										
Voltage(UT): AC 195.5V/50Hz Interval(s) : 10s Times : 3										
Test mod	Test level UT %	Durations (period / ms)	Phase / Result							
			0	45	90	135	180	225	270	315
Voltage interruptions	100%	250	C	C	C	C	C	C	C	C
Voltage dips	20%	250	C	C	C	C	C	C	C	C
	30%	25	B	B	B	B	B	B	B	B
	60%	10	B	B	B	B	B	B	B	B



Test Voltage: AC 253V/50Hz										
Voltage(UT): AC 253V/50Hz Interval(s) : 10s Times : 3										
Test mod	Test level UT %	Durations (period / ms)	Phase / Result							
			0	45	90	135	180	225	270	315
Voltage interruptions	100%	250	C	C	C	C	C	C	C	C
Voltage dips	20%	250	C	C	C	C	C	C	C	C
	30%	25	B	B	B	B	B	B	B	B
	60%	10	B	B	B	B	B	B	B	B

Test engineer: Leben



14.4. Test Photographs





15. EUT Photographs

1) EUT Photo



2) EUT Photo

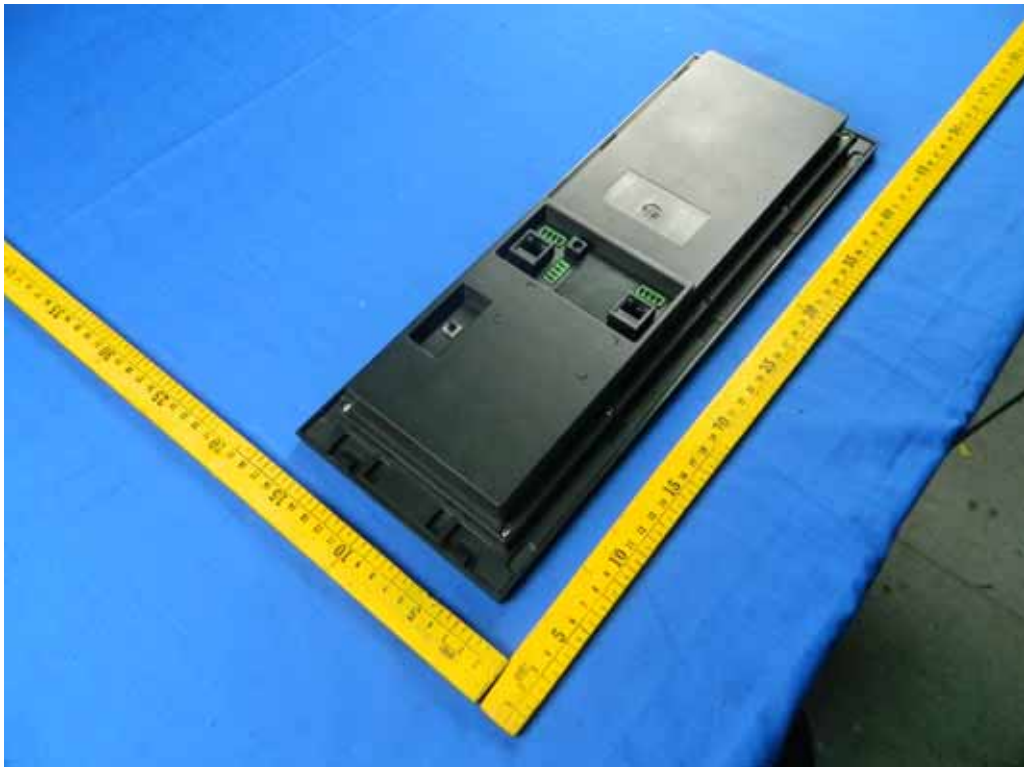



3) EUT Photo



4) EUT Photo





5) EUT Photo(Adapter)



6) EUT Photo(Adapter)





7) EUT Photo(Adapter)



8) EUT Photo(Adapter)





9) EUT Photo(Adapter)

